







|           |       |                |
|-----------|-------|----------------|
| <b>4</b>  | ..... | RACE           |
| <b>20</b> | ..... | MOUNTAINBIKES  |
| <b>26</b> | ..... | SIGNATURE      |
| <b>30</b> | ..... | TREKKING       |
| <b>36</b> | ..... | LIGHTTOURING   |
| <b>48</b> | ..... | COMFORT        |
| <b>58</b> | ..... | E-BIKES        |
| <b>66</b> | ..... | SPECIALS       |
| <b>80</b> | ..... | SPECIFICATIONS |

# About Koga

1974 | 1978 | 1981

1983 | 1984 | 1989

1990 | 1999 | 2000



Handbuilt in Holland



Introduction Koga-Miyata trekking bikes



Greg Herbold World Champion Downhill on Koga-Miyata mountainbike



Sponsor to the professional 'U'sboerke' cycling team



Koga-Miyata Silver Ace Gents introduction lightweight tourer



'WorldTraveller' legend Tilmann Waldthaler



Peter Winnen wins Alpe d'Huez stage in Tour de France on Koga-Miyata



Koga-Miyata cycling team



Leontien Zijlaard-van Moorsel winner of Olympic Gold medals

Komend uit een familie van fietsfabrikanten legde Andries Gastra 35 jaar geleden de basis voor het merk Koga-Miyata. De missie van toen staat nog steeds: het ontwikkelen van superieure kwaliteit met een zeer exclusieve uitstraling en fantastisch rijgedrag.

Koga behoort tot de top in high-end fietsmerken met nog steeds een focus op kwaliteit en innovatie. De nieuwe technieken en materialen die o.a. worden toegepast voor de racefietsen van Theo Bos, Marianne Vos en het Skil-Shimano team vindt u deels ook terug in de fietsen van onze collectie.

In deze brochure krijgt u een goed beeld van de klasse die onze fietsen uitstralen en de passie waarmee ze geheel handmatig worden samengesteld. Met een Koga-Miyata bezit u niet alleen een fiets maar tevens een merk met een indrukwekkende uitstraling.

Raised from a family of cycle makers, Andries Gastra laid the foundations of the Koga Miyata brand 35 years ago. Its original mission has remained true to this day: the development of cycles of first class quality, with highly exclusive style and with superb riding qualities.

Koga is among the very top premium cycle brands, always centred around quality and innovation. New technologies and materials, employed on the racing machines of Theo Bos, Marianne Vos and the Skil-Shimano team, among others, are also found in many of the cycles in our range.

This brochure offers just a glimpse at the sheer class which our cycles exude, and of the passion with which each one is assembled by hand. Owning a Koga-Miyata one does not simply possess a bike, but also a brand with impressive appeal.



Award winning tandem design  
TwinTraveller



Eurobike Award Gold  
E-bike Tesla



Theo Bos on Koga Kimera -  
revolutionary carbon track frame



Multiple World Champion Theo Bos  
winner of Olympic silver on sprint



Vector - Urban Bike  
Gold IF-Design award for innovation



Marianne Vos winner of Olympic  
Gold on Koga Kimera in Beijing



Limited series Koga Aeroblade  
Red Dot Design Award



Material sponsor to the  
Pro Continental team Skil-Shimano



Adaptor - Compact Bike  
Winner Eurobike Award 2009

Aus einer Familie von Fahrradfabrikanten kommend legte Andries Gastra vor 35 Jahren das Fundament für die Marke Koga-Miyata. Die Mission von damals gilt noch heute: das Entwickeln von Fahrrädern in erstklassiger Qualität, mit sehr exklusiver Ausstrahlung und hervorragenden Fahreigenschaften.

Koga gehört zur Spitze der Premium-Fahrradmarken, Qualität und Innovation stehen weiterhin im Mittelpunkt. Die neuen Techniken und Materialien, die unter anderem bei den Rennrädern von Theo Bos, Marianne Vos und dem Skil-Shimano-Team eingesetzt wurden, findet man teilweise in den Fahrrädern unserer Kollektion wieder.

Diese Broschüre vermittelt ein Bild von der Klasse, die unsere Fahrräder ausstrahlen, und von der Leidenschaft, mit der sie alle von Hand montiert werden. Mit einem Koga-Miyata besitzt man nicht nur ein Fahrrad, sondern auch eine Marke mit einer einzigartigen Ausstrahlung.

Originaire d'une famille de fabricants de vélos, Andries Gastra a jeté les bases de la marque Koga-Miyata voici 35 ans. La mission des débuts reste d'actualité : développer des vélos de qualité supérieure avec une aura très exclusive et une conduite absolument fantastique.

Koga fait partie du top niveau des marques « Premium » et la qualité et l'innovation restent au cœur de nos efforts. Les nouveaux techniques et matériaux qui ont été utilisés, entre autres, dans les vélos de compétition de Theo Bos, Marianne Vos et de l'équipe Skil-Shimano se retrouvent dans une partie des vélos de notre collection.

Cette brochure vous donnera une image de la classe qui distingue nos vélos et de la passion avec laquelle ils sont tous montés mains. Avec un Koga-Miyata, vous ne possédez pas seulement un vélo, mais aussi une marque avec un rayonnement inédit.



Dat onze wortels bij de racefiets liggen, is in onze hele racecollectie terug te vinden; (semi-)professionele wedstrijdfietsen en uitstekende modellen voor de toerfietser. Eén ding hebben ze allemaal gemeen: ze profiteren van intensieve 'test drives' door professionals, zoals het Skil-Shimano team en Theo Bos, berijder van een Kimera. De kennis die daarbij wordt verzameld komt natuurlijk onze totale productontwikkeling ten goede. Profiteer ervan mee!

Im Rennrad liegen unsere Wurzeln. Und diese Tatsache zieht sich durch die gesamte Race-Kollektion. Rennmaschinen für den (semi-)professionellen Einsatz und ausgezeichnete Modelle für den Freizeitsport. Eines haben alle gemeinsam: Sie profitieren von den intensiven „Testfahrten“ der Profis, wie dem Team Skil-Shimano und Kimera-Fahrer Theo Bos. Erkenntnisse, die dort gewonnen werden, fließen natürlich in die Entwicklung ein. Profitieren Sie mit!

Our roots are in racing bikes, and this fact is evident throughout our whole Race range, with racing machines for (semi)professional use and superb models for amateur sport. They have one thing in common: they benefit from intensive 'test riding' from the professionals, such as the Skil-Shimano team and Kimera rider Theo Bos. The knowhow which this gives us is naturally fed right back into product development - so you benefit too!

Nos racines se trouvent dans le vélo de course. Cela se fait sentir à travers toute notre collection de vélos de course, qu'ils soient destinés à l'utilisation semi-professionnelle ou au cycliste amateur. Tous partagent la même caractéristique : ils tirent profit des « tests » intensifs par les pros du Team Skil-Shimano et par Theo Bos sur Kimera. Leurs riches expériences en compétition ont été déterminantes pour le développement de cette gamme. Profitez-en !

# FullPro2Light

| Weight: ca. 5,99 Kg | Price: € 6.999,- | ▽ 50 54 56 58 60 62 |

## 5,99 Kg

(UCI - minimum standard 6,8 Kg)  
Frame-weight: ca. 880 gr



- Super lightweight professional bike
- Ultra stiff Ulthymo® carbon fibre frame, FEM optimized (ca. 880 gr) with durable 1K PicoWeave finish
- Full carbon lightweight front fork, FEM optimized
- Complete Shimano Dura-Ace groupset
- Fast Forward wheelset, DTSwiss hubs with ceramic bearings
- 3T-limited series handlebar, stem and seatpost

Colour: Visible carbon 1K

Race

## DURA-ACE



Superlichte full carbon racefiets die aan hoge eisen op het gebied van gewicht en uitrusting tegemoet komt. De voor het frame gebruikte Ulthymo®-vezels hebben bij de Kimera hun unieke kwaliteiten bewezen.

Super-light full carbon racing bike for extreme demands on weight and specification. The Ulthymo®-fibres used in the frame construction have proved their unique qualities on the Kimera.

Superleichtes Full-Carbon Rennrad für die gehobenen Ansprüche an Gewicht und Ausstattung. Die im Rahmenbau eingesetzten Ulthymo®-Fasern haben ihre Einzigartigkeit im Kimera bewiesen.

Un vélo de course en full carbone super léger pour des coureurs exigeant en matière de poids et d'équipement. Les fibres uniques Ulthymo® utilisées pour le cadre ont fait leurs preuves dans le Kimera.





*De nieuwe DURA-ACE. Een geperfectioneerde legende. De ideale balans tussen lichtgewicht, stijfheid en prestatie. Eindelijk verkrijgbaar om het professionele fietsen naar een nóg hoger niveau te tillen.*

*Experience the evolution of perfection. [www.dura-ace.com](http://www.dura-ace.com)*

**DURA-ACE**  
EVOLUTION OF PERFECTION

**SHIMANO**





Albert Timmer, allrounder/climber of the Skil-Shimano team on Koga Team Scandium XXLite

# FullProScandium

| Weight: ca. 7,7 Kg | Price: € 2.699,- | ▽ 50 54 56 58 60 63 |

Race

- Very lightweight and stiff scandium frame, triple butted tubing
- Koga 3K carbon/alloy front fork
- Complete Shimano Ultegra SL double groupset
- Ritchey WCS parts
- Selle Italia Lorica lack saddle

Colour: Pearl white/Nano black

SHIMANO  
ULTEGRA SL



De teamfiets! De wielersprofs van het team Skil-Shimano zijn van de kwaliteiten van de FullProScandium overtuigd. De perfecte combinatie van laag gewicht en stijfheid.

The team bike! Racing professionals such as the Skil-Shimano Team are impressed by the FullProScandium. A perfect combination of low weight and rigidity.

Das Rad der Teams! Rennrad-Profis wie das Skil-Shimano Team sind vom FullProScandium überzeugt. Die perfekte Kombination von Leichtgewicht und Steifigkeit.

Le vélo des équipes ! Des professionnels de la petite reine comme ceux de l'équipe Skil-Shimano ne jurent que par le FullProScandium. Une conjugaison parfaite entre poids-plume et rigidité.



| Weight: ca. 8,7 Kg | Price: € 1.599,- | ▽ 50 54 56 58 60 63 66 |

Race

- Lightweight aluminium 7005 frame, triple butted tubing
- Koga carbon/ally front fork
- Complete Shimano Ultegra SL triple groupset
- PRO PLT handlebar, stem and seatpost
- Selle Italia C2 Special Edition

Colour: Blue metallic/Pearl white/Solid black

SHIMANO  
ULTEGRA SL



Model met een uitstekende prijs-kwaliteitverhouding, geïnspireerd op het Skil-Shimano-team.

Inspired by the Skil-Shimano Team, this model has an excellent price/performance ratio.

Vom Skil-Shimano Team inspiriertes Modell mit sehr gutem Preis/Leistungsverhältnis.

Un modèle inspiré du Team Skil Shimano offrant un bon rapport qualité-prix.



# RoadRacer

| Weight: ca. 7,9 Kg | Price: € 2.399,- (Centaur) | Price: € 2.299,- (Ultegra) | ▽ 50 54 56 58 60 62 |

Race

- Lightweight monocoque frame, Highmodulus carbon fibre, 3K finish
- Koga 3K carbon/alloy front fork
- Available with Shimano Ultegra SL triple or Campagnolo Centaur double groupset
- Wheelset Mavic Aksium (Ultegra)/ Wheelset Campagnolo Khamsyn(Centaur)

Colour: Visible carbon 3K/Pearl white

*Campagnolo*

SHIMANO  
ULTEGRA SL



Het full carbon frame van de RoadRacer werd voor 2009 geoptimaliseerd. Deze lichte allrounder heeft nu een nog betere verhouding tussen gewicht en stijfheid.

The full carbon RoadRacer frame has been optimized for 2009, this lightweight all-rounder now offers an even better stiffness/weight ratio.

Der Full Carbon Rahmen des RoadRacer wurde für 2009 optimiert. Dieser leichte Allrounder bietet jetzt ein noch besseres Verhältnis von Gewicht und Steifigkeit.

Le cadre entièrement fait en carbone du RoadRacer a été optimisé pour 2009. Ce vélo tout usage offre dorénavant un rapport rigidité – poids encore plus performant.



| Weight: ca. 8,3 Kg | Price: € 1.899,- (Ultegra) | Price: € 1.699,- (105) | ▽ 50 54 56 58 60 63 66 |

- Aluminium 7005 frame with monostay
- New Carbon frontfork: more aero dynamics
- PRO PLT handlebar, stem and seatpost
- Available as New Shimano 105 or Shimano Ultegra triple
- Wheelset Mavic Aksium

Colour: Koga blue/Nano black/Brush polish

SHIMANO ULTEGRA SL

SHIMANO 105



Breed inzetbare, betrouwbare aluminium racefiets met carbonvork. Een klassieker in de Koga-collectie.

Reliable aluminium racing bike with carbon fork for a wide range of applications. A classic in the Koga collection.

Robustes Aluminium Rennrad mit Carbongabel für den vielseitigen Einsatz. Ein Klassiker der Koga-Kollektion.

Un vélo de course en aluminium avec une fourche en carbone multi-usage. Un grand classique de la collection Koga.



# Sponsoring Sport

Koga ondersteunt topsporters vanuit een visie: passie voor fietsen. Want dat is het, wat succesvolle sporters kenmerkt: passie, afzien, grensverleggende inzet. Daarbij maakt het niet uit of het om wielrennen, mountainbiken of reizen om de wereld gaat. Iedere rijder is op zoek naar zijn uiterste grenzen. Of dat nu een gouden medaille is of de top van een berg.

Voor Koga betekent sponsoring meer dan alleen demonstratie van technische know-how. We werken nauw samen met onze partners. Zij geven Koga waardevolle suggesties voor verbetering van onze producten. En daar wordt sponsoring interessant voor u. Deze innovaties vindt u in uw eigen Koga terug!

Koga's support for top-level athletes springs from a shared vision: a passion for cycling. Because what makes a successful athlete is passion, dedication, contempt for limits. It doesn't matter whether it's road racing, mountain biking or a world tour: every rider strives to achieve their own personal cycling best, be it a gold medal or scaling a mountain.

And for Koga, sponsorship is more than a demonstration of our technical knowhow: we work closely with our sponsorship partners, and they give us valuable feedback to improve our products. And this makes our sponsorship activities relevant for you, too, because these improvements end up in your very own Koga!



Theo Bos - track cyclist - [www.theobos.com](http://www.theobos.com)



Marianne Vos - allround cyclist - Gold Beijing 2008



Skil-Shimano - cycling team - [www.skilcyclingteam.com](http://www.skilcyclingteam.com)



Leontien Zijlaard-van Moorsel - cycling legend - [www.leontien.nl](http://www.leontien.nl)

# Passion For Cycling

Koga unterstützt Spitzensportler aus einer gemeinsamen Vision heraus: der Leidenschaft für das Fahrradfahren. Denn das ist es, was einen erfolgreichen Sportler ausmacht: Leidenschaft, Einsatz, Grenzen ausloten. Ganz gleich, ob es dabei um Radrennen, Mountainbiken oder um eine Weltreise geht. Jeder strebt seinem eigenen Fahrrad-Höhepunkt entgegen - ob das nun eine Goldmedaille ist oder eine Bergspitze.

Für Koga bedeutet Sponsoring mehr als nur eine Demonstration seines technischen Know-hows. Wir arbeiten eng mit unseren Partnern zusammen. Sie geben Koga wertvolle Hinweise für die Verbesserung unserer Produkte. Und da wird Sponsoring interessant für Sie, denn diese Innovationen finden Sie in Ihrem eigenen Koga wieder!

Koga soutient les sportifs de haut niveau à partir d'une vision commune : la passion du cyclisme. Car c'est ce qui fait d'un athlète un champion : la passion, l'engagement et de repousser les limites. Peu importe qu'il s'agisse de courses de vélo, de VTT ou de faire le tour du monde. Chacun vise à atteindre ses propres objectifs – que ce soit une médaille d'or ou un sommet de montagne.

Pour Koga, le sponsoring signifie bien plus qu'une simple démonstration de notre savoir-faire technique. Nous travaillons en étroite collaboration avec nos partenaires. Ils donnent des indications précieuses à Koga pour améliorer nos produits. A partir de là, le sponsoring devient intéressant pour vous, car ces innovations, vous les retrouvez dans votre propre Koga !



Franco Marvulli - track cyclist - [www.francomarvulli.ch](http://www.francomarvulli.ch)



Nissan mountainbike team - [www.mountainbiketeam.com](http://www.mountainbiketeam.com)



Koga-Miyata - cycling team - [www.koga-miyata-cycling-team.com](http://www.koga-miyata-cycling-team.com)



KNWU - cycling federation/track cycling team - [www.knwu.nl](http://www.knwu.nl)

# Flyer

| Weight: ca. 8,8 Kg | Price: € 1.399,- (105) | Price: € 1.099,- (Tiagra) | △ 50 54 56 58 60 63 66 |

Race

- Lightweight aluminium 7005 frame, double butted tubing
- Koga carbon/ally front fork
- Shimano 105 triple groupset or Shimano Tiagra triple groupset
- PRO handlebar, stem and seatpost
- Foldable Vredestein Fortezza tires with protection layer

Colour: Electric red/Brush polish

SHIMANO **105**

SHIMANO  
**TIAGRA**



De Flyer is het perfecte instapmodel voor sportieve toerrijders en beginnende wielrenners. Natuurlijk ook een echte Koga-kwaliteitsfiets.

The Flyer offers the perfect platform for the sporty touring cyclist or newcomer to racing cycling - naturally with renowned Koga-Miyata quality.

Der Flyer bietet die perfekte Grundlage für sportliche Tourenfahrer und Rennrad-Einsteiger, selbstverständlich in bewährter Koga-Miyata Qualität.

Le Flyer s'impose comme le parfait modèle de base pour le cyclo-randonneur et pour le coureur débutant, les qualités inégalables d'un Koga-Miyata en prime.





- Aluminium 7005 cycle cross frame with very balanced geometry
- Koga 3K carbon/alloy front fork
- Special Tektro Cross brakes
- Wheelset Shimano RS-10
- Schwalbe Racing Ralph Evolution folding tires

Colour: Brush polish/Solid black

SHIMANO **105**



Speciaal voor het veldrijden ontwikkelde fiets, die aan de hand van de ervaringen van voormalig wereldkampioen Richard Groenendaal werd geoptimaliseerd.

Special cross-country-capable cyclocross racer, fine-tuned with the input of former Cross World Champion Richard Groenendaal.

Spezielles geländegängiges CycleCross Rennrad, welches nach den Erfahrungen des erfahrenen Querfeldein-Fahrers Richard Groenendaal optimiert wurde.

Un vélo de course cyclo-cross tout terrain dont la mise au point a été marquée par les expériences de course de l'ancien champion du monde Richard Groenendaal.



# Passion For Cycling

Koga-Miyata proud sponsor  
of the  
Dutch KNWU Track selection



More info: [www.koga.com](http://www.koga.com)



# Kimera frame

| Weight: ca. 1,9 Kg | Price: € 3.499,- | ▽ 54 57 60 63 |

Race

- Identical to Olympic Gold winning frameset (Beijing 2008), FEM-optimized for maximum stiffness and minimum weight
- Ulthymo®-carbon fibre monocoque frame - up to 150% stiffer\*
- Wind tunnel tested - up to 10% better aerodynamics\*
- 'Powertrain' bottom bracket for high energy efficiency
- Koga Track carbon/alloy front fork
- Identical to teamframe of Dutch KNWU track team

\*: compared to top track framesets (as tested by EFBe)

Colour: Visible carbon/Orange



"State of the art" baanframe dat aan extreme eisen voldoet en werd ontwikkeld met de nieuwste knowhow op het gebied van aerodynamica, biomechanica en carbontechnologie.

"State of the art" track frame to exceed the most demanding possible requirements, optimised to the state of the art in biomechanics, aerodynamics and carbon technology.

"State of the art" Bahnrahmen für allerhöchste Ansprüche. Entwickelt und optimiert nach den neuesten Erkenntnissen der Biomechanik, Aerodynamik und Carbontechnik.

Cadre pour la piste optimisé selon les dernières avancées en matière de biomécanique, d'aérodynamisme et de technique carbone pour suffire aux exigences les plus élevées.



# FullProTrack frame

| Weight: ca. 1,4 Kg | Price: € 899,- | ▽ 53 56 59 |

Race

- Lightweight scandium frameset, triple hardened and oval triple butted tubing
- Koga Track carbon/alloy front fork
- Seat tube with special 'aero' shape
- Straight, replaceable rear-ends
- Perfect stiffness for professional, allround track use

Colour: Dutch orange metallic/Pearl white



Scandium frame met rechte patten en voorvork, dat speciaal werd ontwikkeld voor de baan en waarmee al vele professionele successen werden geboekt.

Designed specially for track use, this Scandium frame has straight drop-outs. Multiple wins at professional championships.

Speziell für den Einsatz auf der Bahn konzipierter Scandium-Rahmen mit geraden Ausfallenden. Gut für viele Siege auf professionellen Meisterschaften.

Ce cadre en scandium aux pattes droites a été spécialement conçu pour la piste. Vainqueur multiple aux championnats professionnels.



# Mountainbike



De mountainbike-ervaring van Koga gaat terug tot het begin: Greg Herbold wordt in 1991 wereldkampioen downhill met Koga-Miyata. Sinds 1986 ontwikkelt en bouwt Koga een compact programma mountainbikes met geavanceerde technieken als het XPM-veersysteem en full-carbon als framemateriaal. Getest in de zwaarste wedstrijden door het Nissan Mountainbike Team. Ons doel: mtb's die allereerst moeten overtuigen door verrassende prestaties, dán pas door hun prima looks.

Kogas Erfahrung mit Mountainbikes reicht bis in die Anfänge zurück: Greg Harbold wurde 1991 Downhill-Weltmeister auf einem Koga-Miyata. Seit 1986 entwickelt und baut Koga ein kompaktes Programm an Mountainbikes - mit äußerst fortschrittlichen Techniken wie dem XPM-Federungssystem und Full-Carbon als Rahmenmaterial. In den schwierigsten Wettkämpfen vom Nissan Mountainbike Team getestet. Unser Ziel: MTBs, die vor allem durch überraschende Leistungsstärke überzeugen, und dann noch durch ihr tolles Aussehen.

Koga's experience with mountain bikes goes back to the very beginning: Greg Herbold became Downhill World Champion in 1991 on a Koga-Miyata. Since 1986 Koga has developed and built a compact range of mountain bikes with exceptionally advanced technology such as the XPM suspension system and full carbon frame construction - all tested in the toughest race conditions by the Nissan Mountainbike Team. Our aim: to make MTBs which stand out first and foremost for their exceptional performance, and because they look superb, too.

L'expérience VTT de Koga remonte à nos débuts : Greg Herbold a emporté le titre de champion du monde en descente en 1991 sur Koga-Miyata. Depuis 1986, Koga développe et construit un programme compact de VTT en utilisant des techniques avancées comme le système XPM pour les ressorts et des matériaux de cadre entièrement en carbone. Ils sont testés en conditions de compétition par l'équipe Nissan Mountainbike. Notre objectif : des VTT qui s'imposent d'abord par leur performances surprenantes avant de séduire par leur look d'enfer.

# XT-Carbolite

| Weight: ca. 9,9 Kg | Price: € 2.999,- | ▽ 46 50 53 |

MTB

- Ultra lightweight Highmodulus full carbon monocoque hardtail, FEM optimized
- Fully Shimano XT equipped: gears, brakes and wheels
- Adjustable FOX 32 F 80 RL front fork with 80mm travel and lock-out
- Tested and in use with the Nissan Mountainbike Team

Colour: Visible carbon

SHIMANO  
DEORE XT



Door Koga's ervaring in high-tech carbon beschikt deze superlichte hardtail over de juiste eigenschappen voor cross-country of marathontrips op topniveau. Wedstrijdwinnaar!

Thanks to Koga's experience with high-tech carbon, this super-lightweight hardtail possesses precisely the right qualities for cross-country or marathon rides at the highest level. An event winner!

Dank Kogas Erfahrung mit High-Tech-Carbon verfügt dieses superleichte Hardtail über genau die richtigen Eigenschaften für Cross-Country- oder Marathon-Trips auf Topniveau. Ein Siegertyp!

Grâce à l'expérience de Koga dans l'utilisation du carbone High-Tech, ce VTT rigide présente des caractéristiques parfaites pour le cross-country ou pour des courses marathon au plus haut niveau. Le vélo des gagnants!



# XPM-AM

| Weight: ca. 12,4 Kg | Price: € 2.799,- | ▽ 41 46 51 56 |

MTB

- Highly developed alu 7005 triple butted frame, with 15% more stiffness
- Adjustable rear suspension with Xtreme Pivot Management
- Lightweight rear swing arm with 130mm travel
- Adjustable Fox 32 Float RL front fork with 140mm travel, lock-out and quick release on handlebar
- Complete Shimano XT groupset and disc brakes

Colour: Trooper Green/Pearl white

SHIMANO  
DEORE XT



Voor optimale controle op single trails of fullspeed downhill. Serieuze prestaties door het 100% doelmatige ontwerp en klasse uitrusting.

For optimal control on singletrack or at full speed downhill. Powerful performance thanks to the 100% application-specific design and first class specification.

Für optimale Kontrolle auf Single Trails oder bei Fullspeed Downhill. Starke Leistungen durch das 100%ig auf den Verwendungszweck zugeschnittene Design und die erstklassige Ausstattung.

Pour un contrôle optimal sur single track ou en descente. Des performances solides par un design 100 % efficace et un équipement très classe.





- Highly developed alu 7005 triple butted frame, with 15% more stiffness
- Adjustable rear suspension with improved Xtreme Pivot Management
- Lightweight swing arm with 100mm travel
- Adjustable Rockshox Reba SL front fork with 100mm travel and lock-out
- New Shimano SLX groupset and disc brakes
- Versatile Schwalbe Racing Ralph tires

Colour: Solid black

SHIMANO DEORE SLX



De XPM-M gaat 'all the way' bij marathons en lange dagtochten. Ontwikkeld en ingezet op wedstrijdniveau, dus sterk, licht en met pure kwaliteitscomponenten.

The XPM-M will take you all the way on marathons and long day rides. Developed and tested for competition use and hence strong lightweight and equipped only with top level components.

Das XPM-M geht 'all the way' bei Marathons und langen Tagestouren. Auf Wettkampfniveau entwickelt und eingesetzt, daher stark, leicht und ausschließlich mit Top-Komponenten ausgerüstet.

Le XPM-Marathon tient la route sur marathon et pour des longues sorties à la journée. Développé et utilisé en compétition, il est résistant, léger et dispose des composantes de première qualité.

# X-Runner

| Weight: ca. 10,9 Kg | Price: € 1.599,- | ▽ 41 46 51 56 |

MTB

- Strong and lightweight aluminium frame 7005 design
- Adjustable FOX 32 F 100 R front fork with 100mm travel
- New Shimano SLX groupset with shadow rear derailleur

Colour: Snow white metallic/Solid black

SHIMANO  
DEORE **SLX**



Exact remmen, snel schakelen, scherp sturen en prima looks. De aluminium X-Runner heeft de ambitieuze biker voor 2009 extra veel te bieden.

Precise braking, quick shifting, sharp handling and great looking: the aluminium X-Runner offers a superb package to the ambitious rider in 2009.

Exakt bremsen, schnell schalten, scharf lenken und klasse aussehen. Das X-Runner aus Aluminium hat dem ehrgeizigen Biker von 2009 besonders viel zu bieten.

Freinage précis, changement de vitesse rapide, réactif au pilotage et un look d'enfer. Le X-Runner en aluminium version 2009 offre beaucoup d'extras au biker ambitieux.



- Strong and lightweight aluminium frame 7005 design
- Adjustable Rockshox Tora 318 Solo Air front fork with 100mm travel and lock-out
- Shimano Deore V-brakes
- Ritchey WCS seat post and stem
- Foldable Schwalbe Racing Ralph tires

Colour: Koga blue metallic/Solid black

**SHIMANO**  
**Deore**



Of het nu gaat om stof, zand of modder, de X-Sport heeft precies de componenten waar je als liefhebber prima mee voor de dag komt.

Whether it's dust, sand or mud, the X-Sport has the components which you, as a discerning rider, need to get you through.

Ob es nun um Staub, Sand oder Matsch geht, das X-Sport besitzt genau die Komponenten, mit denen man als Liebhaber gut über die Runden kommt.

A l'aise dans la poussière, le sable ou la boue, les composantes choisies pour le X-Sport permettent au passionné de profiter de chaque instant de sa sortie.

EXPECTED  
2009

# Koga Kimera Road

The first **S**ignature **R**ace Bike



Kimera Road  
koga  miyata

# DeSign your unique Koga

@

[www.koga-signature.com](http://www.koga-signature.com)



## Signature Comfort - Touring



Mijn ideale fiets is een fiets met een lage instap, maar toch sportief met een hoogwaardige versnelling en een sportief stuur, maar wel een lekker zadel. Met Koga Signature kon ik al

mijn wensen realiseren. Mijn fantastische fiets voor elke dag, met mijn naam op het frame.



## Signature Trekking Light



Leicht muss es sein, mein Traumrad, aber stabil. Ich will damit auf meinen Reisen ohne Probleme die Berge hoch kommen, aber muss auch meine gesamte Ausrüstung

mitnehmen. Mit Koga Signature habe ich mein leichtes, stabiles Traumrad zusammengestellt. Super! Das kann ich unterschreiben!

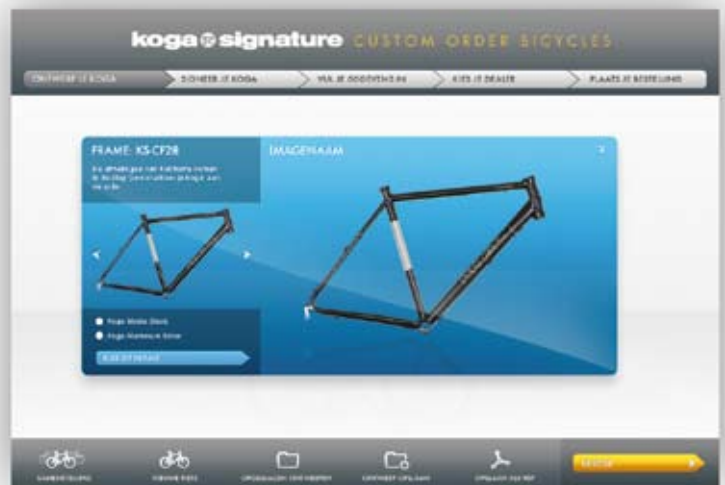

## SIGNATURE.COM

### Signature Fitness



Par le passé, je roulais sur un vélo de course, à l'image des grands du Tour de France, Giro etc. Comme j'ai moins de temps pour rouler actuellement, j'ai voulu me contenter d'un vélo

sportif. Mais rien à faire, on a ses habitudes et ses exigences particulières en tant que gros rouleur. Mon Koga Signature est simple, rien de superflu. Juste tout ce dont j'ai besoin. Mais c'est mon choix personnel, comme on peut le lire sur le cadre.

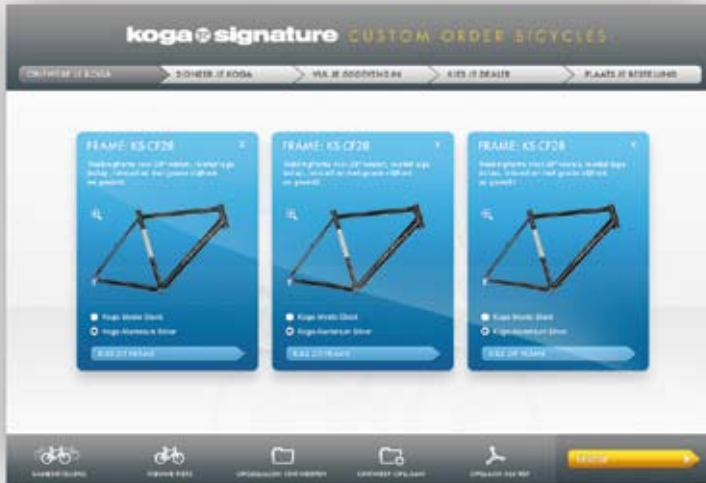

### Signature Trekking Premium



My Koga is my work. My husband and I, we travel through the world to write reports and make pictures. We need a 100% reliable and durable bike. And

we had special wishes. With Koga Signature we designed our best bikes ever, even better than our former bikes – from Koga of course.

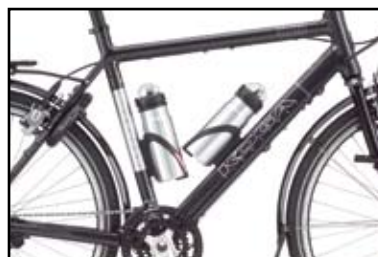

# Trekking

Fietsen is een geweldige manier om de wereld te ontdekken, ver of dichtbij. Koga bouwt al ruim drie decennia fietsen die juist daarvoor zijn bestemd: robuust, duurzaam en functioneel compleet. In de nieuwe trekkingcollectie zijn er drie modellen die zich onderweg ruimschoots hebben bewezen, natuurlijk voorzien van de laatste techniek. Zodat uw fietsreis voorop blijft staan.

Fahrrad fahren ist mit die beste Art, die Welt zu entdecken, ob nah oder fern. Koga baut bereits seit mehr als drei Jahrzehnten Fahrräder, die genau dafür bestimmt sind: robust, langlebig und funktional komplett ausgestattet. In der neuen Trekking-Kollektion gibt es drei Modelle, die sich unterwegs schon reichlich bewiesen haben, natürlich nach dem neuesten Stand der Technik ausgestattet. Für eine unbeschwernte Fahrradreise!

Cycling is the best way to see the world, be it nearby or far away. Koga has built bikes for over three decades which are specifically designed for touring: robust, durable and with functional, full equipment. There are three models in the new Trekking range, all of which have already proven themselves handsomely on the road, and naturally all equipped with state of the art components. For a trouble-free cycle tour!

Rouler à vélo est une façon fantastique de découvrir le monde, proche ou lointain. Koga construit depuis presque trois décennies des vélos qui servent précisément à ça : robustes, durables et totalement fonctionnels. La nouvelle collection trekking contient trois modèles qui ont déjà largement fait leurs preuves sur les routes du monde et qui sont aménagés selon les derniers progrès techniques. Pour que seul le voyage reste au cœur de vos préoccupations.





# WorldTraveller

| Weight: ca. 15,7 Kg | Price: € 1.999,- | ▽ 50 54 57 60 |

Trekking

- Sturdy lightweight 26" alu 7005 trekking frame
- Complete Shimano XT groupset
- Renowned Brooks Flyer saddle
- Many accessories already included
- Excellent on- and offroad qualities

Colour: Anthracite grey metallic

SHIMANO  
DEORE XT



De bijna legendarische aluminium 26" trekkingfiets van Koga. Compact, wendbaar en compleet, voor de meest avontuurlijke reisroutes.

The already legendary aluminium 26"-wheeled Koga touring bike. Compact, manoeuvrable and complete, for the most extreme cycle adventures.

Das schon legendäre Aluminium 26" Trekking-Fahrrad von Koga. Kompakt, wendig und komplett, für die abenteuerlichsten Reiserouten.

Le vélo de trek quasi légendaire aluminium 26" de Koga. Compact, agile et très complet pour des voyages les plus aventureux.



# Randonneur

| Weight: ca. 17,3 Kg | Price: € 1.899,- | △ 50 54 57 60 63 | ▽ 47 50 53 56 |

Trekking

- Lightweight chromoly frame developed for long road trips
- Shimano LX with XT rear derailleur
- Multigrip handlebar
- Automatic LED front and rear light
- Many accessories already included

Colour: Siennablack metallic



Door het karakteristieke rijgedrag van het lichte stalen frame en de nieuwste componenten is de Randonneur al decennia een betrouwbare reisgenoot.

With the characteristic ride of a lightweight steel frame and the latest components, the Randonneur has for decades provided reliable touring transport.

Durch das charakteristische Fahrverhalten des leichten Stahlrahmens und die neuesten Komponenten ist das Randonneur bereits seit Jahrzehnten ein zuverlässiger Reisegefährte.

Grâce au comportement caractéristique d'un cadre léger en acier et aux composants dernier cri, le Randonneur est un compagnon de route fiable depuis des décennies.





- Extra strong lightweight aluminium 7005 frame
- Shimano LX groupset
- Multigrip handlebar
- Automatic LED front and rear light
- Tubus rear carrier and lowrider

Colour: Grey metallic



Reisfiets die zijn praktische kwaliteiten net zo goed bewijst tijdens intensief dagelijks gebruik.

A touring bike whose practical qualities shine through just as much through intensive daily use as on tour.

Reisefahrrad, das seine praktischen Qualitäten genauso gut beim intensiven alltäglichen Gebrauch unter Beweis stellt.

Un vélo de voyage dont les qualités pratiques se révèlent aussi dans un usage intensif quotidien.



# Exploring the Planet

Koga is al jaren toonaangevend als het gaat om robuuste, betrouwbare en zeer complete trekking fietsen. Of het nu gaat om de klassieke Randonneur de ongeëvenaarde WorldTraveller of onze nieuwe Signature lijn, fietsreizigers over de hele wereld zijn het over één ding absoluut eens, er gaat niets boven een Koga! Op deze pagina introduceren wij een selectie van 's werelds meest ervaren fietsreizigers en hun Koga's.

Koga has for many years been leading when it comes to robust, reliable and comprehensively equipped touring bikes. Whether the bike in question is the classic Randonneur, the incomparable World Traveller or our new Signature models, cyclists the world over are united in their verdict: nothing beats a Koga! In these pages we will introduce you to some of the world's most experienced cycle travellers and their Koga bicycles.

Wenn es um robuste, zuverlässige und sehr komplett ausgestattete Reisenräder geht, gibt Koga schon seit Jahren den Ton an. Ob es nun um den klassischen Randonneur, den unübertroffenen World Traveller oder unsere neue Signature-Modelle geht, Fahrradfahrer in der ganzen Welt sind sich in einem Punkt absolut einig: Es geht nichts über ein Koga! Auf dieser Seite stellen wir Ihnen einige der weltweit erfahrensten Fahrradreisenden und ihre Koga-Fahrräder vor.

Depuis de nombreuses années, Koga est le leader incontesté dans le domaine de vélos de trekking robustes, fiables et très complets. Qu'il s'agisse du Randonneur classique, de l'inégalable WorldTraveller ou de notre nouvelle ligne Signature, les voyageurs à vélo du monde entier vous le confirmeront : rien ne dépasse un Koga ! Sur cette page, nous vous présentons quelques globe-trotters cyclistes des plus expérimentés du monde et leur Koga.

## Tilmann Waldthaler

Nationality: Globetrotter, World citizen  
Bicycle: Koga Signature TR-26  
Distance covered: > 430.000 km  
Website: [www.tilmann.com](http://www.tilmann.com)

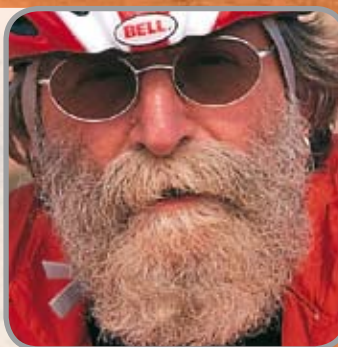



### **Prof. Dr. Dr. Christoph Rohleder**

Nationality: German  
Bicycle: Koga WorldTraveller S  
Distance covered: > 75.000 km  
Website: [www.fernlust.de](http://www.fernlust.de)

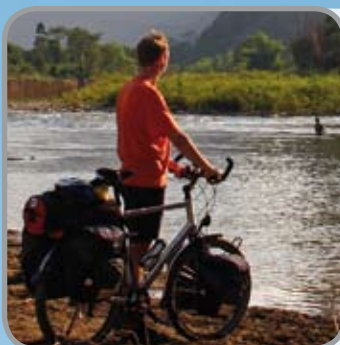

### **Eric Schuijt**

Nationality: Dutch  
Bicycle: Koga Signature TR-26  
Distance covered: > 300.000 km  
Website: [www.carlaeneric.nl](http://www.carlaeneric.nl)



### **Barbara Vetter & Vincent Heiland**

Nationality: German  
Bicycle: Koga WorldTraveller/  
Koga Signature TR-26  
Website: [www.lichtbildarena.de](http://www.lichtbildarena.de)



### **Julia & Stefan Meinhold (BankerBiker)**

Nationality: German  
Bicycle: Koga TwinTraveller  
Distance covered: > 40.000 km  
Website: [www.bankerbiker.de](http://www.bankerbiker.de)



### **Nicole & Ingrid**

Nationality: Belgian  
Bicycle: Koga WorldTraveller/  
TwinTraveller  
Distance covered: > 300.000 km  
Website: [www.nieuwsblad.be](http://www.nieuwsblad.be)

# LightTouring



In dit segment vindt u lichte, sportieve toerfietsen, die elk met hun eigen karakter aan de meest uiteenlopende wensen tegemoet komen. Of u nu dagelijks op de fiets onderweg bent of hem mee op vakantie neemt, hier vindt u de juiste Koga wanneer een laag gewicht uw belangrijkste criterium is.

In this category you will find lightweight, sporty touring bikes which with their very varied characteristics can match a wide range of requirements. Whether you're riding your bike every day for transport, or taking it with you on holiday, you'll find the right Koga for you here, especially if low weight is your top priority.

In diesem Segment finden Sie leichte, sportliche Tourenräder, die in ihrer unterschiedlichen Ausprägung, den vielfältigen Anforderungen entgegenkommen. Ob Sie nun täglich mit Ihrem Rad unterwegs sind oder es mit in den Urlaub nehmen. Hier finden Sie das richtige Koga, wenn Ihr wichtigstes Kriterium das geringe Gewicht ist.

Dans ce segment vous trouvez des vélos de randonnées légers et sportifs dont les différents modèles s'adaptent aux exigences les plus diverses, que vous roulez tous les jours ou simplement en vacances. Si votre premier critère de choix est la légèreté, vous trouverez le Koga qui vous convient dans cette gamme.

# TerraLinerCarbolite

| Weight: ca. 10,8 Kg | Price: € 2.299,- | ▽ 50 54 57 60 |

- Full carbon frame with cable integration and Kimera 'Powertrain' Technology
- Complete Shimano XT groupset
- Hubdynamo with B&M IQ Cyo Senso (32 Lux)
- Tubus Fly rear carrier
- Foldable Schwalbe Marathon Racing tires

Colour: Visible carbon 3K/Black

LightTouring

SHIMANO  
DEORE XT



Ervaringen in de topsport vormen de basis voor deze compleet uitgeruste en superlichte carbon trekkingfiets met een zeer fraai design. Fietsplezier van de bovenste plank.

Lessons learned from top-level sport are the basis for this fully-equipped, super-light carbon touring bike with shapely frame. Riding pleasure to the max!

Erfahrungen aus dem Spitzensport sind die Grundlage für dieses vollausgestattete superleichte Carbon Trekkingrad mit formschönem Design. Das ist Fahrgeuss pur.

Les expériences des athlètes de haut niveau ont servi de base pour ce vélo de trek en carbone super léger, à l'équipement très complet et au design accompli. Le plaisir de rouler, à l'état pur !



# TerraLinerAlloy

| Weight: ca. 11,3 Kg | Price: € 1.299,- |  47 50 54 57 60 63 |

LightTouring

- Lightweight aluminium 7005 frame with cable integration and basements for mudguard, rear carrier and lighting
- Shimano XT components
- Ultra lightweight Suntour Magnesium frontfork
- Foldable Continental Double Fighter tires, 37mm

Colour: Koga Black/Nano Black/Brush polish



De ideale fiets voor fietsers die niet alleen maar sportief bezig willen zijn. De allrounder, of het nu door het veld of over geasfalteerde wegen gaat.

The ideal companion for cyclists whose riding isn't always sporty. An all-rounder, whether you're riding off-road or on the tarmac.

Der ideale Partner für Radfahrer, die nicht immer nur sportlich unterwegs sind. Der Allrounder, ob Sie nun querfeldein oder auf Asphalt unterwegs sind.

Le partenaire idéal pour des cyclistes qui ne font pas que des séances sportives. Le vélo tout-usage que vous partiez à travers champs ou sur l'asphalte.





# RoadChamp-SportsLady

| Weight: ca. 9,2 Kg | Price: € 1.199,- | ▽ 52 54 56 58 60 63 | ↘ 47 50 53 56 |



- Lightweight aluminium 7005 frame with perfect fitness geometry
- Carbon/chromo front fork
- Complete Shimano Tiagra flat handlebar race groupset
- Fi'zi:k Rondine saddle
- Multi purpose pedal: SPD side and platform side
- Vredestein Fortezza tires, 25mm, with protection

**Colour:** High-tech grey (G)/Waterfall blue (L)

LightTouring



SportsLady en RoadChamp zijn fitness bikes voor training en toertochtjes. Een geslaagde combinatie van sportiviteit en comfort.

SportsLady and RoadChamp are fitness bikes for training and day riding. A successful fusion of sport and comfort.

SportsLady und RoadChamp sind Fitnessbikes für Training und Ausfahrten. Ein gelungener Mix von Sportlichkeit und Komfort.

Le partenaire idéal pour des cyclistes qui ne font pas que des séances sportives. Le vélo tout-usage que vous partiez à travers champs ou sur l'asphalte.





# LightDeLuxe

| Weight: ca. 11,9 Kg | Price: € 1.699,- | ▽ 50 54 57 60 63 | ▽ 47 50 53 56 |

LightTouring



- Ultra lightweight aluminium 7005 frame, triple butted tubing
- Carbon front fork
- Complete Shimano XT groupset
- Lightweight Shimano hubdynamo DH-3N80 with LED lighting
- Fi'zi:k Rondine saddle
- Schwalbe Marathon Racer Race Guard tires

Colour: Solid black/High polish

SHIMANO  
DEORE XT



Om het even of u toert of naar het werk fietst de maar 11,9 kg lichte LightDeLuxe is een droomfiets die van elke rit een waar genoegen maakt.

Whether you're a touring or commuting cyclist, the 11,9 kg lightweight LightDeLuxe is a dream bike which makes every ride a pleasure.

Egal, ob Sie Touren- oder Alltagsradler sind, das nur 11,9 kg leichte LightDeLuxe ist ein Traumrad das jede Tour zum Vergnügen macht.

Que vous soyez cycliste au quotidien ou randonneur, le très léger LightDeLuxe est un vélo de rêve qui fait de chaque sortie une partie de plaisir.



# RoadSpeed

| Weight: ca. 13,9 Kg | Price: € 1.399,- | △ 50 54 57 60 63 | ▽ 47 50 53 56 |

LightTouring

- Lightweight aluminium 7005, smooth welded frame
- Integrated Koga Feather front suspension
- New Shimano LX groupset
- Comfort handlebar
- Vredestein Perfect Girando Sportex tires

Colour: Deep Blue/Brush Polish



Qua uiterlijk een heel normale toerfiets, maar in werkelijkheid de perfecte symbiose tussen laag gewicht en comfort.

At first glance a completely normal touring bike, but in fact the perfect symbiosis of low weight and comfort.

Optisch ein ganz normales Tourenrad, in Wirklichkeit die perfekte Symbiose von geringem Gewicht und Komfort.

A première vue, un vélo de randonnée normal, en réalité une parfaite symbiose entre légèreté et confort.



# LightSpeed

| Weight: ca. 13,6 Kg | Price: € 1.299,- | ▽ 50 54 57 60 63 66 | ▽ 47 50 53 56 59 |



- Lightweight aluminium 7005, smooth welded frame
- New Shimano LX groupset
- Comfort handlebar
- Racktime Lightit rear carrier
- Vredestein Perfect Girando Sportex tires

Colour: Winning Silver/Nano Black

LightTouring



Hoewel gebouwd voor een ontspannen zithouding, laat de LightSpeed vanwege zijn stijve frame en lage gewicht een stevig tempo toe.

Although it's designed around a relaxed riding position, the LightSpeed can still keep up a cracking pace thanks to its stiffness and light weight.

Obwohl auf entspannte Sitzhaltung ausgelegt, ermöglicht das LightSpeed wegen seiner Steifigkeit und Leichtigkeit ein flottes Tempo.

Conçu avant tout pour une position assise détendue, le LightSpeed permet de rouler vite grâce à sa rigidité et sa légèreté.



# RoadRunner

| Weight: ca. 13,9 Kg | Price: € 1.499,- | △ 47 50 54 57 60 63 | ▽ 47 50 53 56 |

LightTouring

- Lightweight aluminium 7005, smooth welded frame
- Integrated Koga Feather front suspension
- Shimano LX components
- New powerful Koga Rayo Senso+ IQ-LED front light (32 Lux)
- Multigrip handlebar Koga Dali
- Lightweight Koga Xlite alloy rims - double wall and double eyeletted
- Schwalbe Marathon Racer 35mm tires

Colour: Koga black/Nano black/Brush polish



Voor alle toerfietsers die een zeer sportieve fiets willen, maar comfort ook op prijs stellen.

For all touring riders who like to ride sports-style, but who also know how to appreciate comfort.

Für alle Tourenradler, die zwar sportlich unterwegs sein wollen, aber Komfort zu schätzen wissen.

Pour tous les randonneurs sportifs qui apprécient néanmoins un certain confort.



# LightRunner

| Weight: ca. 13,6 Kg | Price: € 1.399,- | ▽ 50 54 57 60 63 | ↘ 47 50 53 56 |

LightTouring



- Lightweight aluminium 7005, smooth welded frame
- Integrated Koga Feather front suspension
- Shimano LX components
- New powerful Koga Rayo Senso IQ-LED front light (32 Lux)
- Multigrip handlebar Koga Dali
- Lightweight Koga Xlite alloy rims - double wall and double eyeletted
- Schwalbe Marathon Racer 35mm tires

Colour: Blue metallic (G)/ Pearl white(L)



Een lichte, maar robuuste toerfiets voor iedereen die met zijn Koga dagelijks sportief op pad wil zijn. Voor woon-werkverkeer, vrije tijd of op vakantie.

A lightweight, robust touring bike for anyone who wants to be out on a sporty ride every day on a Koga - be it to work, for leisure or on holiday

Leichtes, robustes Trekkingrad für alle, die mit ihrem Koga täglich sportlich unterwegs sein wollen. Egal ob zur Arbeit, in der Freizeit oder im Urlaub.

Un vélo de trek léger et robuste pour tous ceux qui veulent rouler à une allure sportive tous les jours, pour se rendre au travail, pour une sortie de loisir ou en vacances.

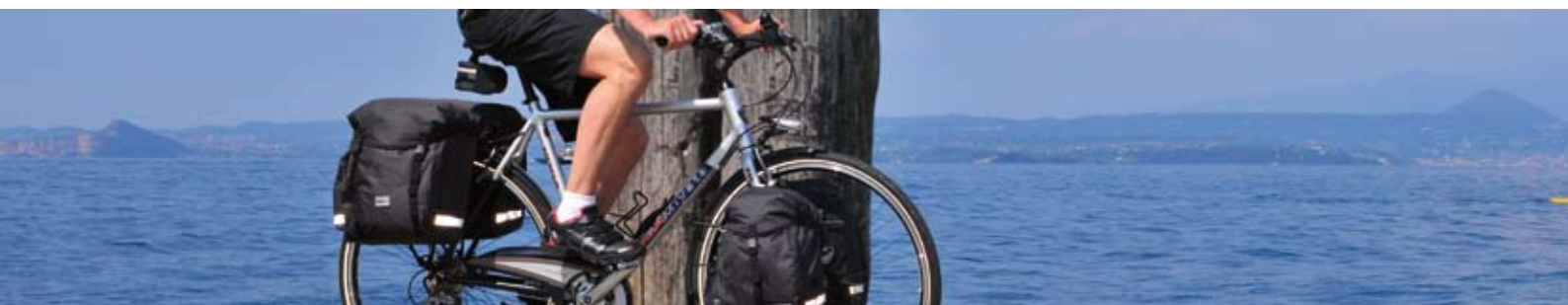

# Passion For Cycling

TerraLinerCarbolite 2009







# Comfort

Eigenlijk spreekt het individuele design van de Comfortklasse voor zichzelf. Maar de ware kwaliteit ervaart u onderweg: aan de lichte rijeigenschappen, de ontspannen zitpositie en het grote, functionele comfort. Koga ontwikkelde daarvoor innovatieve technieken zoals bijvoorbeeld geïntegreerde, lichtgewicht voorvering die polsen en schouders ontziet of de verrassend krachtige Rayo koplamp met lichtsensior. Aangenaam!

Eigentlich spricht das individuelle Design der Komfort-Klasse für sich. Aber die eigentlichen Qualitäten spürt man unterwegs: an den leichtgängigen Fahreigenschaften, der entspannten Sitzposition und dem hohen, funktionalen Komfort. Koga entwickelte dazu innovative Techniken wie eine innen eingebaute, leichte Vorderradfederung, die die Handgelenke und Schultern schont, oder der überraschend leistungsstarke Rayo-Scheinwerfer mit Lichtsensor. Angenehm!

The individuality of the Comfort Class really speaks for itself. But you'll appreciate its intrinsic quality on the road, too: the smooth-running ride, the relaxed riding position and the great functional comfort. To achieve this Koga developed innovative technologies such as the internally concealed, responsive front suspension system to cushion wrist and shoulder joints, and the amazingly powerful Rayo front light with darkness sensor. Delightful!

Le design individuel de la classe Comfort parle pour lui-même. Mais ses vraies qualités se révèlent en route : l'aisance au pédalage, une position détendue et un grand confort fonctionnel. Koga a développé des techniques innovantes comme la suspension avant intégrée très légère qui ménage les épaules et les poignets ou l'éclairage avant Rayo étonnement puissant grâce aux récepteurs lumineux. Agréable !



# Prominence

| Weight: ca. 16,4 Kg | Price: € 1.699,- | ▽ 50 54 57 60 63 66 | ▽ 47 50 53 56 59 |



- New lightweight alloy 7005 frame with integrated Koga Feather front suspension and cables, seat suspension and smart design carrier rack
- Complete Shimano Deore LX 27 groupset
- New powerful Koga Rayo Senso+ IQ-LED front light (32 Lux)
- Safe and easy Clix wheel retention system

Colour: Solid black/High polish

SHIMANO  
Deore **LX**

Comfort



Uitien toerfietsmodel met rijke uitrusting en slank uiterlijk. De Prominence is niet alleen comfortabel maar rijdt ook opvallend soepel

The ultimate touring bike model, generously equipped, with a characterful design. The Prominence offers allround comfort, with a hint of sporting style.

Ultimates Tourenrad-Modell, reich ausgestattet, mit charakteristischem Design. Das Prominence ist rundum komfortabel, mit einem leicht sportlichen Einschlag.

Le modèle ultime d'un vélo de randonnée super équipé au design particulier. Le Prominence est de tout confort et apporte une petite note sportive.



# Alliance NewComfort

| Weight: ca. 17,5 Kg | Price: € 1.699,- |  47 50 53 56 |

Comfort

- Multi-adjustable riding position
- Lightweight alloy 7005 frame with integrated Koga Feather front suspension and seat suspension
- One hand adjustable 27 speed (SRAM Dual Drive)
- Accurate and powerful hydraulic Magura rim brakes
- New powerful Koga Rayo Senso+ IQ-LED front light (32 Lux)
- Optional low entry frame

Colour: Warm light grey/Pearl midnight blue



De naam zegt het: New Comfort verlegt de grens in comfortabel toerfietsen. Dankzij bijzondere details is elk model uitgebreid instelbaar, voor een optimale zitpositie.

Ingebouwde vering en een nieuw ontwikkelde zithouding ontzien rug, schouders en polsen, met behoud van dat geweldige fietsgevoel. Kortom: onze business class.

The name says it all: New Comfort sets a new benchmark for comfortable touring bikes. Thanks to careful detail design, each model is multi-adjustable to achieve a perfect riding position. Integrated suspension and a newly-developed riding posture de-stress the back, shoulders and wrists: the pleasure of riding remains undiminished. In short, it's our business class.

Der Name sagt alles: New Comfort verschiebt die Grenze bei den komfortablen Tourenrädern. Dank besonderer Details ist jedes Modell in mehrerer Hinsicht verstellbar, für eine optimale Sitzposition.

Eingebaute Federung und eine neu entwickelte Sitzposition entlasten den Rücken, die Schultern und Handgelenke - das tolle Fahrgefühl bleibt erhalten. Kurzum: unsere Business-Klasse.

Le nom l'indique déjà : New Comfort déplace les limites du confort en randonnée cycliste. Grâce à des détails particuliers, chaque modèle offre un vaste choix de réglages pour une position assise optimale. Une suspension intégrée et une position assise spécialement étudiée se traduisent par un confort inégalable au niveau du dos, des épaules et pour les poignets, tout en gardant des bonnes sensations cyclistes. Bref : notre business class.



**NC** NEWCOMFORT

# Alliance NewComfort

| Weight: ca. 17,5 Kg | Price: € 1.699,- | △ 50 54 57 60 63 | ▽ 47 50 53 56 |



- Multi-adjustable riding position
- Lightweight alloy 7005 frame with integrated Koga Feather front suspension and seat suspension
- One hand adjustable 27 speed (SRAM Dual Drive)
- Accurate and powerful hydraulic Magura rim brakes
- New powerful Koga Rayo Senso+ IQ-LED front light (32 Lux)
- Optional low entry frame

Colour: Warm light grey/Pearl midnight blue

Comfort



Absoluut topmodel met ontspannen rijeigenschappen en een ergonomisch geoptimaliseerde zithouding, mét behoud van licht sportieve toerfietskwaliteiten.

Absolute top model with relaxing ride characteristics and an ergonomically optimized riding position - without losing the feel of a somewhat sporty touring bike.

Absolutes Topmodell mit ergonomisch optimierter Sitzhaltung für entspanntes Radfahren. Die leicht sportlichen Tourenrad-Qualitäten bleiben erhalten.

Le top-modèle par excellence pour des sorties détendues grâce à une position assise ergonomique optimisée, tout en gardant les caractéristiques d'un vélo de randonnée légèrement sportif.



# Confidence

| Weight: ca. 18,3 Kg | Price: € 1.399,- | △ 50 54 57 60 63 | ▽ 47 50 53 56 59 |

Comfort

- New lightweight alloy 7005 frame design with integrated cables, adjustable front and seat suspension
- Shimano Deore 27 speed
- Multigrip handlebar with leather grips
- Semi sportive Selle Royal Wave saddle
- Accurate and powerful hydraulic Magura brakes

Colour: Quartz grey metallic/Solid black



Ook voor langere of meerdaagse toertochten is de Confidence een tot in detail complete reisgenoot. Zeer allround model.

The Confidence is the complete touring bike down to the finest detail, even for long, multi-day tours. An allrounder!

Auch für längere oder mehrtägige Touren ist das Confidence ein bis ins Detail kompletter Reisegefährte. Ein Allrounder!

Pour des randonnées plus longues ou de plusieurs jours, le Confidence est le parfait compagnon de route. Un modèle tout usage.



| Weight: ca. 18,5 Kg | Price: € 1.299,- | △ 50 54 57 60 63 | ▽ 47 50 53 56 |

Comfort



- Lightweight alloy 7005 frame design with integrated cables with adjustable front and seat suspension
- Easy shifting Shimano Deore 24 speed groupset
- Semi sportive Selle Royal Wave saddle
- New powerful Koga Rayo Sense IQ-LED front light (32 Lux)

**Colour:** Azure blue metallic/Pearl silver



De handgebouwde perfectie van Koga voor wie graag fietst en wil genieten; van dagelijks woon-werkverkeer tot stevige dagtochten inzetbaar.

A hand-finished masterpiece from Koga for everyone who loves to savour the cycling experience: ideal for anything from daily commuting to invigorating day rides.

Die handgefertigte Perfektion von Koga für alle, die das Fahrradfahren genießen möchten: vom täglichen Pendeln bis hin zu strammen Tagestouren einsetzbar.

La perfection faite main par Koga pour ceux qui aiment rouler et se faire plaisir ; du cycliste qui se déplace au quotidien entre sa maison et son lieu de travail jusqu'au randonneur confirmé.



# SilverAce

| Weight: ca. 19,7 Kg | Price: € 1.299,- | △ 50 54 57 60 63 | ▽ 47 50 53 56 59 |

Comfort

- Lightweight alloy 7005 frame
- Adjustable front and seat suspension
- Low maintenance rollerbrakes and closed chain case
- Internal 8 gear Shimano Nexus Premium
- New powerful Koga Rayo Senso IQ-LED front light (32 Lux)

Colour: Blue grey metallic/Solid black



Onderhoudsarm model voor in of om de stad. De SilverAce laat zien dat betrouwbaarheid en degelijkheid prima samengaan met groot fietsplezier, het jaar rond.

Low-maintenance model for town riding and beyond: the SilverAce combines reliability and robust build with a hugely pleasurable ride all year round.

Wartungsarmes Modell für die Stadt und die Umgebung. Das SilverAce vereint Zuverlässigkeit und Solidität mit großem Fahrradvergnügen rund ums Jahr.

Un modèle qui demande peu d'entretien, conçu pour la ville et ses alentours. Le SilverAce est la preuve même que fiabilité et plaisir de rouler peuvent aller de pair, tout au long de l'année.





- Lightweight alloy 7005 frame
- Adjustable front and seat suspension
- Low maintenance rollerbrakes and closed chain case
- Internal 8 gear Shimano Nexus Premium
- New powerful Koga Rayo Senso IQ-LED front light (32 Lux)

**Colour:** Bordeaux red metallic/Pearl silver



De SilverAce is ook verkrijgbaar in klassiek Bordeaux red metallic.

The SilverAce is also available in classic Bordeaux red metallic.

Das SilverAce ist auch erhältlich in klassisch Bordeaux red metallic.

Le SilverAce est aussi disponible en classique Bordeaux red metallic.



# Passion For Cycling

New Prominence 2009





- Very lightweight alloy 7005 frame
- Internal 8 gear Shimano Nexus Premium
- Sportive V-brake
- Practical chain guard
- Strong Tubus trekking carrier rack

Colour: Sapphire blue metallic/High polish



Een verbazend lichte citybike met sportief-trendy look en feel. Dagelijks praktisch inzetbaar maar evengoed klaar voor een snelle rit.

A surprisingly light city bike with a sporty, trendy look and feel. For fast daily transport.

Ein überraschend leichtes Citybike mit einem sportlich-trendigen Look & Feel. Praktisch für alle Alltagsfahrten, aber auch eine schnelle Tour.

Un vélo de ville étonnamment léger avec un look et un comportement sportif branché. Pratique pour une utilisation quotidienne, mais toujours prêt pour une sortie rapide.



# E-Bikes

Steeds meer fietsers ontdekken de voordelen van de E-Bike. Want daarmee fietst u lichter, sneller en misschien zelfs vaker dan met een 'gewone' toerfiets. De hoogwaardige Tesla-serie laat u ruime keus: wilt u een onopvallend ingebouwde accu, een afneembare batterij, of allebei? De vrijwel onzichtbare aandrijving, de nieuwe ION-motoren en een grote actieradius maken de Tesla-modellen tot een gezond en aangenaam fietsalternatief. En met de optionele Xtra Garantie is ook het onderhoud zorgenvrij geregeld (alleen voor de Benelux).

Immer mehr Radler entdecken die Vorteile des E-Bikes. Denn damit fährt man leichter, schneller und vielleicht wahrscheinlich öfter als mit einem 'normalen' Tourenrad. Die hochwertige Tesla-Serie bietet eine breite Auswahl: möchten Sie einen unauffällig eingebauten Akku, einen abnehmbaren Akku mit Tasche oder beides? Der fast unsichtbar eingebaute Antrieb, die neuen ION-Motoren und der große Aktionsradius machen die Tesla-Modelle zu einer gesunden und angenehmen Alternative.

Ever more cyclists are discovering the advantages of E-Bikes. With them, you can ride easier, faster and perhaps even more often than on a 'normal' touring bike. The high quality Tesla range offers you a free choice: would you prefer a discreetly concealed battery, a removable battery pack, or both? The almost invisible, built-in drive system, the new ION motor and the extended range make the Tesla models a healthy, attractive alternative.

De plus en plus de cyclistes découvrent les avantages du E-Bike. Car avec un E-Bike vous ne roulez pas seulement plus facilement et plus vite, mais probablement aussi plus souvent qu'avec un vélo « classique ». La série Tesla haut de gamme vous offre un vaste choix : vous voulez une batterie discrète et intégrée, une batterie échangeable ou les deux ? La propulsion par le quasi invisible moteur ION et un grand rayon d'action font des modèles Tesla une alternative saine et agréable au vélo traditionnel.





- Lightweight aluminium 7005 frame
- Adjustable front suspension with lightweight front fork
- New ION motor for excellent performance, super silent
- 3 support levels, riding characteristics personally adjustable in software
- Multigrip handlebar with leather grips
- Accurate and powerful hydraulic Magura rim brakes
- Shimano 21 speed with LX rear derailleur

Colour: Bordeaux red/Winning silver



De overtreffende trap in fietsen met trapondersteuning. Behalve de stille en krachtige aandrijving geniet u van de zeer luxe uitrusting.

The superlative electric-assisted cycle. You will savour the ease of a quiet and powerful drive and luxurious specification.

Der Superlativ der Fahrräder mit Trittonterstützung. Man kommt in den Genuss eines leisen und kräftigen Antriebs sowie einer sehr luxuriösen Ausstattung.

Il offre un coup de pédale inégalable grâce à l'assistance au pédalage. En dehors de la propulsion silencieuse et puissante vous apprécierez l'équipement de grand luxe.



# E-Bikes



## 'DE BESTE E- BIKE?'

Sinds de introductie in 2006 is de Tesla-serie als toonaangevend ontwerp onderscheiden met (internationale) awards en vakprijzen.

Dat is niet zonder reden!

Een Tesla is herkenbaar aan het slanke design met onopvallende aandrijving. De prachtige details ademen kwaliteit.

Niet verbazingwekkend ook, dat de stille en krachtige ION-aandrijving juist in de Tesla optimaal tot zijn recht komt. Want met óf zonder trapondersteuning rijdt iedere Tesla opvallend licht, stil en soepel. Die superieure klasse ervaart u natuurlijk het beste zélf ... onderweg!

## 'THE BEST E-BIKE?'

Since its launch in 2006, the Tesla range's groundbreaking design has been honoured with numerous (international) design awards and prizes.

And not without good reason!

You will appreciate the Tesla's sleek design and unobtrusive drive system, and the quality is evident in the finest details. So it's not surprising that the quiet but powerful ION drive is employed to its very best effect in the Tesla. With or without pedal assist, the Tesla rides remarkably easily, quietly and smoothly. The best way to convince yourself of its premium-class quality is of course to ride it for yourself!

## 'DAS BESTE E-BIKE?'

Seit seiner Einführung 2006 wurde die Tesla-Serie aufgrund ihres wegweisenden Designs mit (internationalen) Awards und Fachpreisen ausgezeichnet.

Nicht ohne Grund!

Ein Tesla erkennt man am schlanken Design mit dem unauffälligen Antrieb. Den tollen Details sieht man die Qualität an. Nicht überraschend daher, dass der leise und leistungsstarke ION-Antrieb beim Tesla optimal eingesetzt werden kann. Denn mit oder ohne Trittonterstützung fährt jedes Tesla auffallend leicht, leise und sanft. Von dieser Extraklasse überzeugt man sich natürlich am besten selbst ... unterwegs!

## 'LE MEILLEUR E-BIKE?'

Depuis son introduction en 2006, la série Tesla a collectionné des prix et Awards professionnels internationaux en tant que concept révolutionnaire.

A raison !

On reconnaît un Tesla à ses lignes élégantes et une propulsion discrète. Des détails fabuleux respire la qualité. On ne s'étonnera guère que la propulsion puissante et silencieuse ION s'exprime de manière optimale sur le Tesla. Que l'on roule avec ou sans assistance au pédalage, le Tesla s'avère léger, silencieux et souple. Pour se convaincre de sa classe supérieure... enfourchez-le !

Slank ontwerp met vrijwel onzichtbaar ingebouwde aandrijving en geweldige fiets eigenschappen, ook zonder ondersteuning. Winnaar van internationale vakprijzen.

Eenvoudige bediening via één afneembaar display op het stuur, tevens elektronisch slot. Ook afleesbaar: snelheid, dagteller, vulling van de batterij en service-informatie.

Drie keuzestanden voor trapondersteuning: Eco, Normal en Power. Uniek: speciale rijprogramma's installeerbaar voor heuvelgebied, toertochten enz.

De bekende ION-aandrijving werkt stil, krachtig, is duurzaam en reageert aangenaam soepel. De ondersteuning werkt alleen indien u trapt.

Betrouwbaar en veilig: de ION-motor voldoet als één van de weinige aan de EMC-norm, verplicht voor de Europese CE-keur

Krachtige accu's van het NiMH-type; momenteel veiliger én krachtiger dan Li-ion batterijen. Snel oplaadbaar na elke rit, eenvoudig via het stopcontact.

Sleek design with almost invisible integrated drive system, and excellent handling, even without pedal assist. International award winner.

Easy to use removable handlebar display, with electronic locking function. Also displayed are: speed, trip distance, battery charge level and service information.

Three levels of pedal assist: Eco, Normal and Power. Unique capacity to install special ride programs for hilly terrain, touring etc.

The well-known ION drive works quietly, powerfully, is long-lasting and applies the power smoothly. Pedal assist engages only while you pedal.

Reliable and safe: the ION motor is one of the few models to conform to EMC standards, compulsory for the European CE mark.

Powerful NiMH batteries; currently safer and higher-performance than Li-ion rechargeables. Quick recharge after every ride, simple plug-in mains charger.



Schlankes Design mit fast unsichtbar eingebautem Antrieb und tollen Fahreigenschaften, auch ohne Trittonterstützung. Gewinner internationaler Fachpreise.

Einfache Bedienung über ein abnehmbares Display am Lenker, zugleich elektronisches Schloss. Auch ablesbar: Geschwindigkeit, Tageszähler, Ladezustand der Batterie und Service-Information.

Drei Stufen der Trittonterstützung: Eco, Normal und Power. Einzigartig: spezielle Fahrprogramme für hügeliges Gelände, Touren etc. installierbar.

Der bekannte ION-Antrieb arbeitet leise, leistungsstark, ist langlebig und reagiert angenehm sanft. Die Trittonterstützung arbeitet nur, wenn man tritt.

Zuverlässig und sicher: der ION-Motor erfüllt als einer der wenigen die EMC-Norm, Pflicht für das europäische CE-Zeichen.

Leistungsstarke Akkus der Type NiMH; momentan sicherer und leistungsstärker als Li-ion-Batterien. Schnell aufladbar nach jeder Fahrt, einfach an der Steckdose.

Design élégant avec propulsion intégrée quasi invisible et aux qualités de conduite inédites, même sans assistance. Il a remporté des concours professionnels internationaux.

Utilisation facile grâce au display amovible sur le guidon qui sert également de cadenas électronique. Indications de vitesse, kilométrage journalier, état de charge de la batterie, informations de service.

Trois réglage de l'assistance au pédalage : Eco, Normal et Power. Unique : des programmes spécifiques pour terrain vallonné, randonnées à télécharger.

La propulsion ION bien connue est silencieuse, puissante et endurante et s'enclenche avec souplesse. L'assistance ne fonctionne qu'en pédalant.

Fiable et sûr : le moteur ION est un des rares à répondre aux normes EMC, obligatoire pour obtenir le sigle CE européen.

Batteries puissantes du type NiMH ; plus sûres et plus puissantes pour que les actuelles batteries Li-ion. Se recharge rapidement à n'importe quelle prise électrique.

# Tesla-TL

| Weight: ca. 28,5 Kg | Price: € 2.799,- | △ 54 57 60 | ▽ 47 50 53 56 |

Electric hybride

- Lightweight aluminium 7005 frame
- New ION motor for excellent performance, super silent
- 3 support levels, riding characteristics personally adjustable in software
- New powerful Koga Rayo Senso+ IQ-LED front light (32 Lux)
- Maintenance friendly Shimano roller brakes
- Shimano 21 speed

Colour: Warm light grey/Pearl midnight blue



De Koga E-Bike voor iedere dag. Snel en zonder overmatige inspanning naar het werk of heerlijk toeren. Nieuwe, krachtige ION-aandrijving.

The Koga E-Bike for everyday use. Ride to work or take a tour fast and without unnecessary exertion. New, more powerful ION drive.

Das Koga E-Bike für jeden Tag. Schnell und ohne übermäßigen Einsatz zur Arbeit fahren oder Touren unternehmen. Neuer, leistungsstarker ION-Antrieb.

Le E-Bike de Koga pour tous les jours. Vous vous rendez rapidement et sans grand effort à votre lieu de travail ou randonnez à l'aise. Nouvelle et puissante propulsion ION.





| Weight: ca. 28,5 Kg | Price: € 2.799,- | ▽ 54 57 60 | ▽ 47 50 53 56 |

Electric hybride



- Lightweight aluminium 7005 frame
- New ION motor for excellent performance, super silent
- 3 support levels, riding characteristics personally adjustable in software
- New powerful Koga Rayo Senso+ IQ-LED front light (32 Lux)
- Maintenance friendly Shimano roller brakes
- Shimano 21 speed

Colour: Winning silver/Marine grey/Nano black



De Tesla is ook verkrijgbaar in Winning silver/Marine grey/Nano black.

The Tesla is also available in Winning silver/Marine grey/Nano black.

Das Tesla ist auch erhältlich in Winning silver/Marine grey/Nano black.

Le Tesla est aussi disponible en Winning silver/Marine grey/Nano black.



# ION Technologie



Voor slechts €169,-

## Xtra Garantie \*

5 jaar lang geen onverwachte reparatiekosten aan uw E-bike? Dat kan met de Xtra Garantie! Regelmatig onderhoud geeft extra

zekerheid en voorkomt verrassingen. Juist bij een fiets met elektronische trapondersteuning is dat wel zo prettig én gemakkelijk! Met de 'Xtra Garantie' verlengt u de standaard garantie op alle Tesla-modellen van 2 naar 5 jaar, en dat voor het eenmalige vaste bedrag van € 169,-. Daarmee zijn alle reparaties kosteloos (slijtagedelen uitgezonderd).

De Xtra Garantie kan ook ná aanschaf van een Koga-Miyata Tesla worden afgesloten. Vraag uw Koga-Miyata dealer naar de exacte mogelijkheden en voorwaarden van deze service.

\* Only for the Benelux/Nur für Benelux/Seulement pour le Benelux.



| Model:                   | Tesla-S                       | Tesla TL/TI       | Tesla RE                     |
|--------------------------|-------------------------------|-------------------|------------------------------|
|                          | Touring/<br>Town &<br>Country | Town &<br>Country | Town/<br>Country/<br>Leisure |
| Battery removable        | -                             | -                 | ✓                            |
| Range Extender available | ✓                             | ✓                 | -                            |
| Price in €               | 3.099,-                       | 2.799,-           | 2.899,-                      |

## Electrisch fietsen is een verrassend alternatief

Fietsen met elektrische trapondersteuning heeft verrassende voordelen.

Want dankzij de inschakelbare ondersteuning gaat fietsen met tegenwind of heuvelop voortaan vederlicht. Een prima reden om eerder, vaker en langer de fiets te pakken. Voor werk, ontspanning, uw conditie of een snelle boodschap... of alles tegelijk! In iedere Koga-Miyata Tesla zit de superieure ION-aandrijving vrijwel onzichtbaar ingebouwd in het modern ontwerp. De eenknopsbediening is eenvoudig en alleen een stopcontact is nodig. De E-bike is de nieuwste definitie van fietsplezier!

## Fahrradfahren mit elektrischer Unterstützung - eine überraschende Alternative

Fahrradfahren mit elektrischer Trittunterstützung hat überraschende Vorteile: Denn dank der einschaltbaren Unterstützung geht das Fahrradfahren auch bei Gegenwind oder bergauf spielend leicht. Gute Gründe, um früher, öfter und länger Fahrrad zu fahren. Für den Weg zur Arbeit, zur Entspannung, für eine gute Kondition oder einen schnellen Einkauf - oder auch alles zugleich. In jedem Koga-Miyata Tesla sitzt der erstklassige ION-Antrieb, fast unsichtbar eingebaut im modernen Design. Die Bedienung mit einem Knopf ist simpel, nur eine Steckdose ist nötig. Das E-Bike ist die neueste Definition von Fahrradvergnügen!



## Cycling with electric assist – an amazing alternative!

Cycling with electric pedal assist offers amazing advantages. With the switchable electric assist you can ride into headwinds or uphill effortlessly: a good reason to ride earlier, more frequently and further. To work, for relaxation, for fitness or just to get about quickly... or all of these together! Inside every Koga-Miyata Tesla is installed the first-class ION motor, almost invisibly integrated within a modern bike design. It's easy to use with a single button, and plugs in to the mains to charge. E-bikes simply redefine the pleasure of cycling!

## Le vélo électrique, une alternative surprenante

Rouler sur un vélo avec assistance électrique au pédalage a des avantages étonnants. Car grâce à l'assistance facile à enclencher, on pédale sans peine même face au vent ou en pente. Autant de raisons pour prendre le vélo plus vite, plus souvent et pour des trajets plus longs. Pour se rendre au travail, se détendre, améliorer sa condition physique ou faire une course rapide...ou tout au même temps ! Chaque Koga-Miyata Tesla est équipé de la propulsion ION de qualité supérieure, quasi invisible grâce à son intégration dans un design moderne. Un coup de pouce suffit pour l'enclencher et il se recharge via une prise électrique. Le E-Bike est une nouvelle définition du plaisir de rouler !

| Maximum Distance * | Eco (km) | Normal (km) | Power (km) |
|--------------------|----------|-------------|------------|
|                    | 55-90    | 40-55       | 30-40      |
|                    | 45-60    | 30-45       | 20-30      |
|                    | 35-50    | 25-35       | 15-25      |

\* The maximum distance is affected by a variety of factors such as: wind, terrain, body weight and packaging, tire pressure and temperature.





- Lightweight aluminium 7005 frame
- Integrated Koga Feather front suspension and seat suspension
- 3 support levels, riding characteristics personally adjustable in software
- External battery (11Ah) easily removable for charging
- Shimano 21 speed
- Sportive design with vivid riding characteristics

Colour: Nano black

Electric hybride



Licht sportief fietsen en tóch een steun in de rug, dat is de Tesla RE. Wendbaar en comfortabel rijdend. De accu is eenvoudig afneembaar van de drager.

A fast, sporty ride, but with a helping hand at your back: that's the Tesla RE. Nippy and comfortable to ride. Battery can easily be detached from the rack.

Leicht sportlich Fahrrad fahren und doch eine Unterstützung im Rücken: das ist das Tesla RE. Wendig, Komfort beim Fahren. Der Akku kann einfach vom Träger abgenommen werden.

Faire du vélo de façon sportive mais pouvoir quand même compter sur un coup de pouce, c'est ça le Tesla RE, agile et confortable. La batterie se retire facilement de son support.



# Specials

Bijzondere vormen van mobiliteit verdienen binnen de Koga-collectie hun eigen segment. Op de navolgende bladzijden vindt u speciale compacte fietsen, de prijswinnende stadfiets Vector en de compact bike Adaptor.

Mobility options unique to the Koga range deserve a category of their own. Over the following pages you will discover exceptional folding and compact bikes, the prize-winning Vector city bike and the compact bike Adaptor.

Einer Mobilität, die in der Koga-Kollektion einzigartig ist, gebührt auch eine eigene Rubrik. Auf den nächsten Seiten finden Sie spezielle Falt und Kompakträder, das preisgekrönte Cityrad Vector und das Kompaktbike Adaptor.

La mobilité qui caractérise singulièrement toute la collection Koga mérite aussi une catégorie à part. Sur les pages suivantes vous découvrez des vélos particulièrement compacts ou pliables, le vélo urbain Vector et le vélo compacté Adaptor.





- Full suspension aluminium 7005 foldable frame
- SRAM X.9 components
- Accurate and powerful hydraulic Magura HS-33 rim brakes
- Additional rear disc brake for long descents
- SON hub dynamo
- Continental Travel Contact tires
- Folding size: 113x45x131 cm, length: 250cm

**Colour:** Aluminium paint/Grey polish



Koga's unieke full suspension vouwtandem heeft zich met zijn bijzondere kwaliteiten al in ruime mate in de praktijk bewezen. Fietsplezier voor twee!

Koga's unique full-suspension folding tandem has long since proven its quality. Twice the riding fun!

Koga's einzigartiges vollgefedertes Falttandem hat seine Qualität bereits vielfach unter Beweis gestellt. Fahrspaß für zwei!

L'unique tandem pliable et suspendu de Koga a déjà prouvé ses qualités à des multiples reprises. Le plaisir de rouler à deux !

# Adaptor

| Weight: ca. 13,4 Kg | Price: € 1.499,- | Frame sizes: S/M M/L |

Specials

- Lightweight aluminium 7005 Compact Bike, 20" wheel size
- Low maintenance carbon belt drive with Shimano 8 speed hub gear
- Vredestein Moiree shock reducing balloon tires
- Super adjustable - telescopic seat post and stem, folding pedals
- Folding sizes: S/M: 150 X 87 X 72cm  
M/L: 157 X 93 X 79cm
- Very comfortable riding performance

**Colour:** Nano black/Chrome red/High polish

De Adaptor is een volwaardige toerfiets, die in de auto, caravan, camper of op de boot kan worden meegenomen, zodat men nergens van fietsplezier verstoken hoeft te blijven.

De Adaptor is simpel, compact en schoon. Stuurstang en zadel worden simpelweg ingeschoven, terwijl pedalen en stuur worden ingeklapt. Daarna is de Adaptor compact genoeg om te transporteren.

The Adaptor is a full-performance touring bike which you can take with you in a car boot, mobile home, boat or caravan, without missing out on ride quality.

The Adaptor is simple, compact and clean. Stem and seatpost can simply be pushed in, pedals and handlebars be folded up. This makes the Adaptor compact enough for transport.

Der Adaptor ist ein vollwertiges Trekkingrad, das im Auto, Wohnwagen, Boot oder Wohnmobil mitgenommen werden kann, ohne auf Fahrradvergnügen zu verzichten.

Der Adaptor ist einfach, kompakt und sauber. Lenkerstütze und Sattel werden einfach eingeschoben und Pedalen und Lenker werden eingeklapt. Dadurch ist der Adaptor kompakt genug, um ihn zu transportieren.

L'Adaptor est un vélo de trek complet qui s'empporte facilement en voiture, en caravane ou en bateau pour ne pas devoir renoncer aux plaisirs sur deux roues.

L'Adaptor est simple, compact et propre. Les tiges de selle et de cintre s'enfoncent facilement et les pédales et le guidon peuvent être rabattus. Ainsi compacté, l'Adaptor prend un minimum de place lors du transport.

EXPECTED  
2009



- 1 Carbon riemaandrijving: lichtlopend, onderhoudsarm (rekvrij) en schoon. Ontziet kleding en interieur.
- 2 In een handomdraai verandert de Adaptor in een laag en smal pakketje.
- 3 Makkelijk op te tillen; u zet de Adaptor zo in of op auto, auto of caravan
- 4 Lichtgewicht vering en stabiele wegligging, dankzij het ronde en brede profiel van de lichtlopende Vredestein Moiree Ballonbanden.
- 5 Soepel rijden, gemakkelijk schakelen en weinig onderhoud met de Shimano Nexus Premium 8-versnellingsnaaf.
- 6 2 sizes fit all. Met 2 framematen en een slim stelsysteem is de Adaptor flexibel in te stellen op de juiste fietshouding.

- 1 Quiet, grease-free and low-wear: not a chain but a belt drive. Good for your clothing and furniture.
- 2 With just a few easy hand actions the Adaptor converts into a narrow package.
- 3 Easy to carry, fits in a car, on a boat or with you in your mobile home
- 4 A suspension effect and solid roadholding comes from the wide, round profile of the easy-rolling Vredestein Moiree balloon tyres
- 5 Rides fast, shifts smoothly, and has low maintenance with its Shimano Nexus 8 Premium hub gear.
- 6 2 sizes fit all. With two frame sizes and a clever adjustment system, the riding position on the Adaptor is just as comfortable as on a normal touring bike.

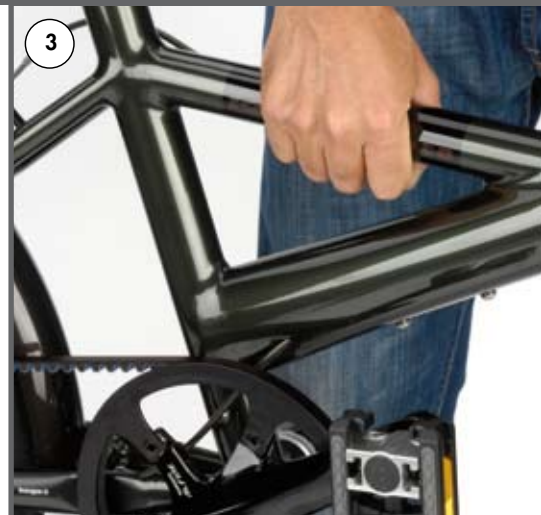

- 1 Still, fettfrei und wenig Verschleiß: keine Kette sondern ein Riemenantrieb. Schont Kleidung und Einrichtung
- 2 Im Handumdrehen verändert der Adaptor in ein schmales Paket.
- 3 Einfach zu tragen, passt ins Auto, aufs Boot oder mit in den Wohnwagen
- 4 Federung und stabile Straßenlage durch das runde und breite Profil der leichtlaufenden Vredestein Moiree Ballonreifen.
- 5 Schnell fahren, flüssig schalten und wenig Wartung mit der Shimano Nexus 8 Premium Nabenschaltung.
- 6 2 sizes fit all. Mit zwei Rahmenmaßen und einem intelligenten Einstellsystem ist die Sitzposition auf dem Adaptor genauso komfortabel, wie auf einem normalen Trekkingrad.

- 1 Silencieuse, sans graisse et résistante à l'usure : la courroie à la place d'une chaîne. Vos vêtements et votre intérieur restent propres.
- 2 En un coup de main, l'Adaptor se transforme en paquet facile à ranger.
- 3 Simple à porter, il se range dans la voiture, sur le bateau ou dans la caravane.
- 4 Un amorti supérieur, une meilleure stabilité et une faible résistance sur la route grâce au profil rond et extra large des pneus Vredestein Moiree.
- 5 Rouler vite, changer de vitesse facilement et ne pas se soucier de l'entretien grâce au changement de vitesses en moyeu Shimano Nexus 8 Premium.
- 6 2 tailles pour tous. Deux tailles de cadres et un système de réglage intelligent rendent la position assise sur l'Adaptor aussi confortable que sur un vélo de trekking normal

# Vector

| Weight: ca. 15,9 Kg | Price: € 1.499,- |  50 54 57 60 |

Specials

- Lightweight 26" aluminium 7005 frame, stable and directframe geometry
- Accurate and powerful hydraulic Magura HS-11 brakes
- Low maintenance: Shimano Nexus 8-speed Premium hub gear with chainglider
- Schwalbe Big Apple 50mm shock reducing tires
- Automatic LED lighting

Colour: Starry Night



De ideale fiets voor het verkeer in de (grote) stad. Wendbaar en veilig, comfortabel en desondanks zeer sportief. Als fiets voor dagelijks gebruik valt hij nauwelijks te overtreffen.

The ideal bike for mixing with (big) city traffic. Nippy and safe, comfortable but nonetheless super-sporty. Its everyday capability is hard to beat.

Das ideale Rad für den (Groß-)stadtverkehr. Wendig und sicher, komfortabel und trotzdem super sportlich. Seine Alltagstauglichkeit ist schwer zu übertreffen

Le vélo idéal pour la circulation urbaine. Souple et sûr, confortable et quand même super sportif. Sa multifonctionnalité au quotidien est inégalable.



# Founder-S

| Weight: ca. 14,3 Kg | Price: € 1.499,- | Frame sizes (cm) Unisize |

Specials

- Koga design full suspension aluminium 7005 frame
- Shimano Capreo 9-speed
- Telescopic seatpost and stem
- Schwalbe Marathon plus tires
- Folding size: 83x43x93cm (HxBxL)
- Very comfortable riding performance

Colour: NanoBlack/Chrome Red/High Polish



De Founder-S kan als de fiets onder de vouwfietsen worden beschouwd. Hij is vrijwel als normale toerfiets te berijden, maar is klein en compact in het transport.

The Founder-S puts the bike back into folding bike. It rides almost like a normal touring bike, but can be stashed away small.

Das Founder-S ist das Fahrrad unter den Falträdern. Es fährt sich nahezu wie ein normales Tourenrad, lässt sich allerdings klein verstauen.

Le Founder-S est un vrai vélo parmi les vélos pliables. Il se comporte sur la route presque comme un vélo de randonnée classique, mais se range dans un minium d'espace.

# Quality/Lifetime Warranty

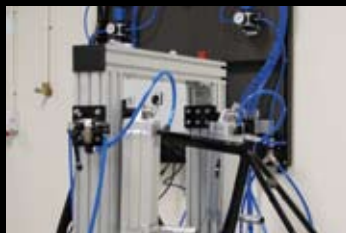

**LIFETIME**  
koga@miyata warranty  
THE QUALITY PEOPLE IN CYCLING

**English**

From 2007 onwards all models, all Koga-Miyata frames and unsuspended front forks (aluminum, scandium, and chromoly) for non-professional use have a lifetime warranty on the occurrence of design or manufacturing faults (excludes paint damage).

See [www.koga.com](http://www.koga.com) for more details

**Deutsch**

Alle Kogamodelle ab 2007, alle Koga-Miyata Rahmen und ungefederten Vorderradgabeln (Aluminium, Scandium und Chrom-Molybdän) für den nicht-professionellen Einsatz haben eine lebenslange Garantie beim Auftreten von Konstruktions- und Produktionsfehlern (Lackschäden ausgeschlossen)

Weitere Informationen unter [www.koga.com](http://www.koga.com)

**LIFETIME**  
koga@miyata warranty  
THE QUALITY PEOPLE IN CYCLING

**Nederlands**

Vanaf de collectie 2007 is op alle Koga-Miyata frames en ongeveerde voorvorken voor niet professioneel gebruik (aluminium, scandium of chromomolybdeen) een levenslange garantie van toepassing bij het optreden van ontwerp- of productiefouten (lakschade uitgesloten).

Kijk op [www.koga.com](http://www.koga.com) voor meer informatie

**Le Français**

Tous les modèles actuels, tous les cadres Koga-Miyata et fourches non-suspendues de la roue avant (aluminium, scandium et chrome-molybdène) pour usage non-professionnel sont couverts par une garantie à vie contre les vices de construction et de production (dommages du vernis exclus).

Plus d'information sur [www.koga.com](http://www.koga.com)



**Chromomolybdeen:** een klassieker onder de frame-materialen. Een superieure staalvariant. Ideaal voor frames waarbij een optimum moet worden gezocht tussen duurzaamheid, comfort, stijfheid en gewicht.

**Chromium Molybdenum:** a classic frame material. A superior option to steel, it is ideal for frames requiring optimum balance between durability, comfort, stiffness and weight.

**Chrom-Molybdän:** Ein klassisches Rahmen material.

Dieses Material ist Stahl überlegen und optimal für Rahmen geeignet, die ein ideales Gleichgewicht zwischen Dauerhaltbarkeit, Komfort, Steifigkeit und Gewicht erfordern.

**Chrome molybdène:** communément appelé « chromoly », l'acier au chrome molybdène est une matière de cadre classique. Supérieur à l'acier ordinaire, il permet de concilier de manière optimale les impératifs de résistance, de confort, de rigidité et de légèreté.



**Carbon:** voor wie het uiterste uit zijn fiets wil halen. Carbon biedt de mogelijkheid om optimaal te construeren ten aanzien van stijfheid en gewicht.

**Carbon:** for anyone who wants to get the ultimate out of their bike. In terms carbon is the optimal construction material.

**Carbon:** Für jene, die alles aus ihrem Rad heraus-holen wollen. Was Steifigkeit und Gewicht angeht, ist Carbon das optimale Baumaterial.

Das Endergebnis sind superleichte Rahmen und perfekte Steifigkeit.

**Carbone :** la matière idéale en termes de rigidité et de légèreté. Les cadres en fibres de carbone sont ultra-légers et parfaitement rigides. Pour tous ceux qui exigent de leur vélo les plus hautes performances.



**Aluminium 7005:** Één van de meest hoogwaardige aluminium legeringen op de markt. De unieke samenstelling van deze legering maakt het mogelijk om zeer stijve en tegelijkertijd lichte frames te bouwen. De drie dubbele warmte behandeling maakt het frame daarnaast nog extra sterk.

**Aluminium 7005:** An exceptionally high quality aluminium alloy. Its unique composition of alloys makes it possible to create very lightweight and stiff frames. The triple hardening heat treatment makes it strong construction

**Aluminium 7005:** Eine der hochwertigsten Aluminiumlegierungen, die es gibt. Die einzigartige Zusammenstellung der Legierung ermöglicht die Konstruktion von sehr steifen, aber gleichzeitig leichten Rahmen. Die dreifache Wärmebehandlung verleiht dem Rahmen extra Stabilität.

**Aluminium 7005 :** Un des meilleurs alliages d'aluminium de haute qualité qui existent. La composition unique de cet alliage permet une construction très rigide tout en permettant de faire un cadre très léger. Le traitement thermique lui assure une stabilité extraordinaire.

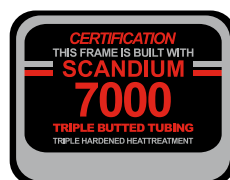

**Scandium:** zeer exclusief materiaal afkomstig uit de ruimtevaart industrie. Scandium combineert de duurzaamheid van aluminium met de stijfheid en het gewicht van carbon.

**Scandium:** a unique material, originally used in the space industry. Scandium combines the durability of aluminium with the stiffness and weight advantage of carbon.

**Scandium:** Ein ursprünglich in der Weltraumtechnik eingesetztes Spezialmaterial. Scandium vereint die Dauerhaltbarkeit von Aluminium mit der Steifigkeit und dem Gewichtsvorteil von Carbon.

**Scandium :** une matière très légère aux propriétés uniques, utilisée dans l'industrie aéronautique. Cet ingrédient d'alliage permet de concilier la résistance de l'aluminium à la rigidité et la légèreté d'un carbone.

## PAS OP MET INTERNET VERKOOP

Het kan voorkomen, dat u nieuwe Koga-Miyata fietsen kunt aanschaffen via het internet, afkomstig van aanbieders die niet staan geregistreerd als officieel merkdealer van Koga-Miyata (dus geen 'Selected Koga Dealer' of 'Koga Full Range Dealer').

Vaak worden deze fietsen aangeboden met extra korting. Indien u na aankoop via deze weg aanspraak wenst te maken op service en garantie blijkt het echter vaak erg lastig om uw fiets terug te sturen naar de firma die uw Koga-Miyata heeft geleverd.

Kiest u daarentegen voor aanschaf bij uw plaatselijke Selected Koga Dealer of Full Range Dealer, dan is dit traject echter wél goed geregeld. Wij raden u dan ook aan, altijd uw Koga-Miyata aan te schaffen bij de officiële Koga Selected en/of Full Range Dealer. Snelle en vakkundige service en onderhoud zijn dan gegarandeerd.

## VORSICHT MIT INTERNET-VERKÄUFEN

Manchmal werden neue Koga-Miyata-Räder über das Internet angeboten, allerdings von Händlern, die nicht als offizielle Händler der Marke Koga-Miyata registriert sind (und sich demnach nicht 'Selected Koga Dealer' oder 'Koga Full Range Dealer' nennen dürfen).

Diese Händler locken mit besonders günstigen Preisen. Die Rechnung kommt oft nach dem Kauf über diesen Vertriebsweg, nämlich wenn Sie Service oder Garantie einfordern möchten: dann wird es sehr kompliziert, Ihr Rad an die betreffende Lieferfirma zu diesen Zwecken zurückzusenden.

Entscheiden Sie sich hingegen für die Anschaffung über einen Selected Koga Dealer oder Full Range Dealer in Ihrer Nähe, sind derartige Leistungen sehr gut geregelt. Daher raten wir Ihnen, Ihr Koga-Miyata stets über einen offiziellen Koga Selected und/oder Full Range Dealer anzuschaffen: nur dann sind schneller und fachkundiger Service sowie optimale Wartung garantiert.

## BE CAREFUL WITH INTERNET SALES

Sometimes new Koga-Miyata bikes are offered via the Internet but from dealers who are not registered as official dealers for the Koga-Miyata brand (and hence are not allowed to call themselves 'Selected Koga Dealer' or 'Koga Full Range Dealer').

These dealers entice customers with especially attractive prices. But the true cost is only apparent after buying in this way, namely if you require service or need to make a claim under warranty, because it becomes very complicated in such a case to send the bike back to the relevant supplier for that purpose.

But these matters are handled proper if on the other hand you decide to buy from a Selected Koga Dealer or Full Range Dealer in your neighbourhood. We therefore advise you to always buy your Koga-Miyata bike from an official Koga Selected and/or Full Range Dealer: only then can you guarantee getting quick and expert service and proper maintenance.

## ATTENTION SI VOUS ACHETEZ VIA INTERNET

Certains Koga-Miyata sont proposés via internet, mais il s'agit de distributeurs qui ne sont pas enregistrés par Koga comme distributeurs officiels (et qui n'ont pas le droit d'arborer les logos 'Selected Koga Dealer' ou 'Koga Full Range Dealer').

Ces distributeurs offrent parfois des vélos à des prix particulièrement alléchants. Mais le vrai prix n'apparaît qu'après vente, notamment si votre vélo a besoin d'un entretien ou s'il faut remplacer une pièce sous garantie. Il s'avère souvent très compliqué de renvoyer le vélo au fournisseur concerné.

Vous n'aurez en revanche aucun souci de ce genre si vous décidez d'acheter votre vélo chez un distributeur agréé 'Koga Selected' ou 'Full Range Dealer' dans votre quartier. Nous vous conseillons donc de toujours acheter un Koga-Miyata chez un distributeur officiel 'Koga Selected' ou 'Full Range Dealer': c'est la seule garantie d'obtenir un service rapide et des entretiens fournis par un expert compétent.

Perfection into Detail



### **Prominence - nieuwe ontwikkelingen**

Koga's nauwe band met de veeleisende topsport is rechtstreeks herkenbaar in het niveau van de nieuwe toerfietscollectie. Innovatieve, functionele techniek, waarbij gemak, duurzaamheid, gewicht en design voorop staan. Topmodel Prominence is hiervan het toonbeeld: ondanks het slanke frameontwerp is er ingebouwde lichtgewicht (1,2 kg) voorvering. Dankzij de lagering is de werking soepel en direct, waardoor schouders en polsen worden ontzien. En onopvallend functioneel is de nieuwe drager, optisch een eenheid met het framedesign maar karakteristieke lijnen en bijpassende jasbeschermers.

### **Prominence - new developments**

Koga's close connections with top-level touring cyclists are instantly evident when you examine the new touring bike collection. Innovative, functional technology which puts comfort, durability, weight and design as top priorities. The flagship model, the Prominence, is the poster child for this approach: despite the slim frame design a lightweight (1.2 kg) front suspension system is built in. Its smooth bearings provide a plush and direct response, de-stressing shoulders and wrists. The new carrier rack is also appealingly functional, forming a single visual unit with the frame design, offering characteristic style and with a matching clothing protector

### **Prominence mit neuen Entwicklungen**

Kogas enge Verbindung zum Tourenfahren auf Topniveau erkennt man sofort am Niveau der neuen Tourenrad-Kollektion. Innovative, funktionale Technik, bei der Komfort, Ausdauer, Gewicht und Design an vorderster Stelle stehen. Das Topmodell Prominence ist dafür das Vorzeigemodell: trotz des schlanken Rahmendesigns wurde eine leichte (1,2 kg) Vorderradfederung (Koga Feather) eingebaut. Dank der Lagerung funktioniert sie sanft und direkt, wodurch Schultern und Handgelenke geschont werden. Auffallend funktional ist der neue Gepäckträger, optisch eine Einheit mit dem Rahmendesign, doch mit charakteristischen Linien und passendem Kleidungsschutz.

### **Le Prominence évolue grâce à des nouveaux développements**

Le lien étroit entre Koga et le sport de haut niveau a marqué les exigences auxquelles répond la nouvelle collection de vélos de randonnées. Des techniques innovantes et fonctionnelles qui mettent l'accent sur le confort, la durabilité, le poids et le design. Le modèle phare Prominence en est l'illustration : une suspension légère (1,2 kg) est intégrée dans un cadre au design effilé. Souple et directe dans son fonctionnement, elle soulage les épaules et les poignets. Fonctionnel et discret, le nouveau porte-bagage se fond dans les lignes du cadre et forme un ensemble harmonieux avec le garde-boue arrière.

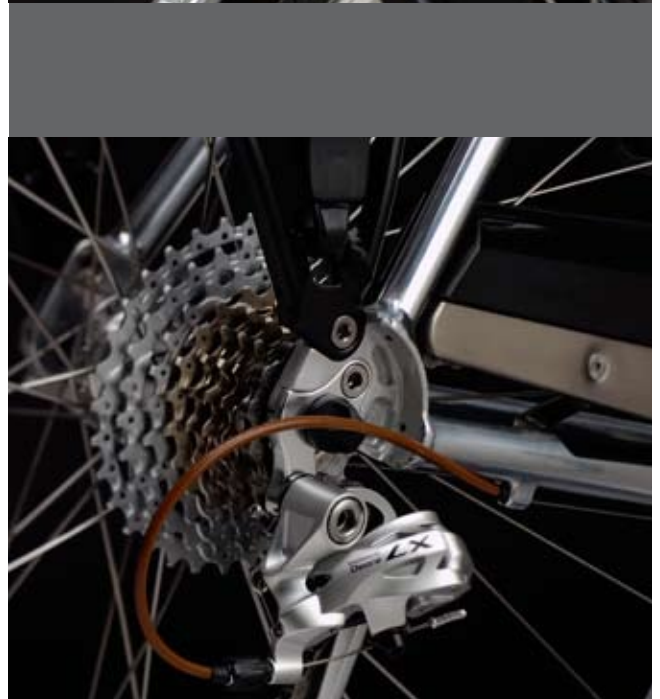



### Prominence - nieuwe ontwikkelingen

De fietskoplamp "Rayo" is het resultaat van de samenwerking tussen Koga en Busch&Müller. De doelstelling was een koplamp te ontwikkelen die optisch onopvallend is en met stuurtas of fietsmand bruikbaar. De oplossing werd gevonden in de vormgeving.

Door middel van een natuurlijk sandwichconstructie wordt de lamp aan het voorspatbord bevestigd. De nieuwe LED-technologie (32 Lux) maakte het door zijn hoge lichtopbrengst mogelijk de lamp klein te houden en er desondanks een reflector in te integreren.

De door een naafdynamo gevoede "Rayo" is voorzien van een senso-stand, maar kan ook door middel van makkelijk te bereiken schakelaar ingeschakeld worden. De nieuwe "Rayo Senso+" beschikt tevens over een standlichtfunctie. De lichtbundel kan nauwkeurig worden gericht door middel van een getrappt instelmechaniek.

### Prominence - new developments

The "Rayo" front light is the result of a collaboration between Koga and Busch&Müller. The objective was to develop a front light which would not immediately be visually obvious, and which would also remain functional when using a basket or handlebar bag. The final design represents the solution to all of these requirements.

The LED headlight is attached to the mudguard using an organic sandwich-type structure. New, more powerful LED technology (32 Lux) permits a compact headlight design which nevertheless incorporates a reflector.

The hub dynamo driven "Rayo" is equipped with a sensor system, but it can also be turned on manually via a very easily accessible switch. The new Rayo Senso+ has an additional standlight function. The beam angle can be precisely set using the click-action adjuster, and it then stays reliably in place.

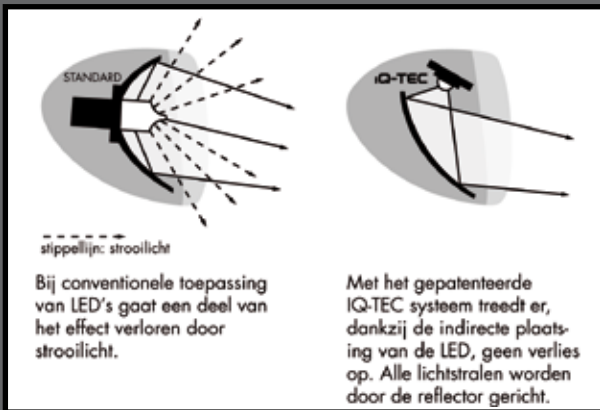

### Prominence mit neuen Entwicklungen

Der Scheinwerfer "Rayo" ist das Ergebnis der Zusammenarbeit von Koga und Busch&Müller. Die Zielsetzung war die Entwicklung eines Scheinwerfers, der optisch nicht sofort ins Auge fällt und auch mit Lenkertasche oder Korb noch nutzbar ist. Die Gestaltung ist die Antwort auf diese Anforderung.

Mittels einer natürlichen Sandwich-Konstruktion wird die LED-Lampe auf dem Schutzblech befestigt. Eine neue leistungsstarke LED-Technologie (32 Lux) ermöglicht es, den Scheinwerfer klein zu gestalten und trotzdem noch einen Reflektor zu integrieren.

Der Nabendynamo betriebene „Rayo“ ist mit einem Senso-Stand ausgerüstet, kann aber auch mit einem sehr einfach erreichbarem Schalter in Betrieb genommen werden. Der neue Rayo Senso+ hat außerdem eine Standlichtfunktion. Durch eine einrastende Einstellung kann die Position des Lichtkegels genau bestimmt werden und bleibt auch erhalten.

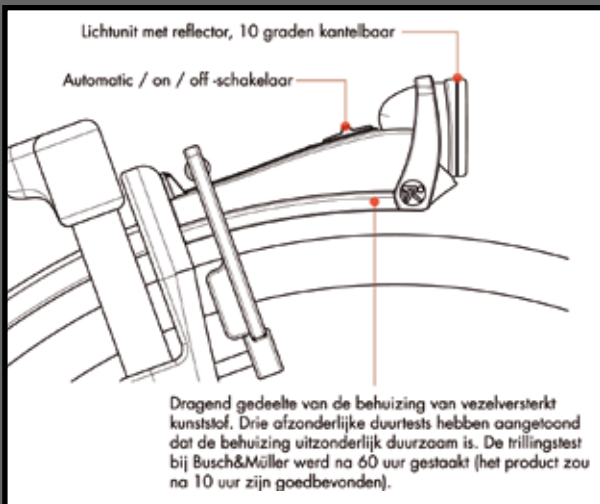

### Le Prominence évolue grâce à des nouveaux développements

Le phare „Rayo“ est le fruit d'une étroite collaboration entre Koga et Busch&Müller. L'objectif était de développer un phare avant plutôt discret mais pleinement fonctionnel même si un sac ou un panier sont fixés à l'avant du guidon. Son design répond à ces exigences.

Au moyen d'une construction naturelle en « sandwich » des matériaux synthétiques, la lampe LED se fixe sur le garde-boue. Une nouvelle technologie LED (32 Lux) plus puissante a permis de réduire la taille du phare tout en intégrant quelques réflecteurs dans le boîtier.

Alimenté par une dynamo en moyeu, le « Rayo » est équipé d'un 'Senso-Stand', mais peut également être allumé via un bouton facile d'accès. Le nouveau Rayo Senso+ dispose en plus d'une fonction 'feux de stationnement'. Un réglage graduel avec crans d'arrêt permet de régler l'orientation du faisceau lumineux de manière précise et durable.



Perfection into Detail



**KOGA**  
FEATHER  
shock eliminator

**KOGA** R A Y O  
POWERED BY BUSCH & MÜLLER

# In the Spotlight

**NL** - Alle frames zijn voorzien van een zeer hoogwaardige laklaag (3 verschillende lagen), de Crystal Clear Protection Coating (CCPC). Voor bescherming en zeer heldere kleurweergave.

**EN** - All frames are finished with a very high quality triple-layer paint which we call Crystal Clear Protection Coating (CCPC). For Protection and vivid colour reproduction.

**DE** - Alle Rahmen werden mit einer sehr hochwertigen Lackierung versehen (3 verschiedenen Schichten) das sogenannte Crystal Clear Protection Coating (CCPC). Zum Schutz und für klare Farbwiedergabe.

**FR** - Tous les cadres sont couverts d'une couche de vernis de grande qualité appliquée en trois couches distinctes dans un procédé particulier, appelé le "Crystal Clear Protection Coating" (CCPC).

**NL** - Waar mogelijk, zijn de lasnaden op een Koga frame perfect geëgaliseerd (super smooth welding) zodat er een volkomen glad oppervlak ontstaat. Dit vermindert tevens de kans op roestvorming rondom de lasnaden.

**EN** - Wherever possible the weld beads on a Koga frame are levelled to perfection (super smooth welding), so that the result is a completely smooth surface. This also minimises the risk of rusting around the weld bead.

**DE** - Wo möglich, sind die Schweißnähte an einem Koga-Rahmen perfekt egalisiert (super smooth welding), sodass eine vollkommen glatte Oberfläche entsteht. Das vermindert zugleich das Risiko der Rostbildung.

**FR** - La majorité des soudures est parfaitement égalisée (super smooth welding) pour créer une surface tout à fait lisse. Cela diminue également le risque de voir apparaître des taches de rouille autour des soudures.

**NL** - De keuze voor de banden is altijd afhankelijk van het soort fiets. Criteria zijn rolweerstand, lange levensduur en voorkomen van lekkage.

**EN** - A choice of tires always depends on the type of bike. Criteria are: drag, durability and resistance to tire leakage

**DE** - Die Wahl der Reifen ist immer abhängig vom Verwendungszweck. Kriterien sind Rollwiderstand, lange Lebensdauer und Pannenschutz.

**FR** - Le choix des pneus dépend toujours du type de vélo. Les critères sont la résistance au roulage, la durée de vie et la prévention de crevaisons.

**NL** - De leren handvatten zijn gemaakt van de allerbeste leersoorten en zorgen voor een aangenaam comfortabele grip tijdens het fietsen.

**EN** - The leather grips are made from the highest grades of leather and ensure a pleasant and comfortable grip as you ride.

**DE** - Die Ledergriffe werden aus den besten Ledersorten gefertigt und sorgen für einen angenehmen und bequemen Griff beim Radfahren.

**FR** - Les poignées sont fabriqués à partir de meilleures sortes de cuir et assurent une prise en main très agréable et confortable.



**NL** - Aluminium frames van Koga hebben een 3-voudige wanddikte (triple butted). Hierdoor kunnen de frames optimaal gespecificeerd worden qua gewicht en stijfheid.

**EN** - Koga's aluminium frames use three different wall thicknesses (triple butted) so that the frames can be optimized for low weight and high stiffness.

**DE** - Kogas Aluminium-Rahmen haben eine dreifach variierende Wandstärke (triple butted): so können die Rahmen optimal hinsichtlich Gewicht und Steifigkeit abgestimmt werden.

**FR** - Les cadres en aluminium de Koga sont "triple butted", les tubes présentent une épaisseur variable selon les endroits ce qui permet d'ajuster parfaitement le poids et la rigidité du cadre.





**NL** - Voor de meest cruciale draaiende onderdelen wordt gebruik gemaakt van zeer lichtlopende hoogwaardige industriële lagering. De levensduur is significant hoger dan bij normale lagering.

**EN** - For the cycle's critical moving parts, very easy-rolling industrial sealed bearings are fitted. You will enjoy a considerably longer life than normal bearings.

**DE** - Bei den entscheidenden sich drehenden Teilen werden sehr leichtgängige hochwertige Industrielager verwendet. Die Lebensdauer ist dadurch bedeutend länger als bei normalen Lagern.

**FR** - Les plus importantes pièces tournantes sont pourvues de roulements à billes industriels. Une coque spéciale les protège et leur assure une longévité nettement supérieure à celle de roulements à billes habituels.

**NL** - De meeste Koga's zijn uitgerust met het unieke Brake Power Control systeem (BPC). Het BPC systeem zorgt voor een meer geleidelijke overbrenging van remkracht op de fiets waardoor de kans op remblokkering significant verminderd wordt.

**EN** - Most Kogas are equipped with the Brake Power Control system (BPC). The BPC system ensures even transmission of braking force to the bicycle and minimises the risk of locking a wheel.

**DE** - Die meisten Kogas verfügen über ein Brake Power Control-System (BPC). Das BPC-System sorgt für eine gleichmäßigere Übertragung der Bremskraft auf das Fahrrad und minimiert so das Risiko, dass die Bremsen blockieren.

**FR** - La plupart des vélos Koga disposent d'un système de freinage "Brake Power Control" (BPC). Le système BPC assure une transmission plus régulière de la force de freinage sur le vélo et réduit ainsi le risque de blocage des freins.

**NL** - LED verlichting heeft een significant helderder lichtopbrengst, dus betere zichtbaarheid en dus veiliger.

**EN** - LED lighting technology offers significantly greater illumination - making you easier to see for extra safety.

**DE** - LED-Beleuchtung von wesentlich öherer Leuchtkraft - ein Sicherheitsfaktor, da man besser gesehen wird.

**FR** - Le LED éclairage offre une luminosité nettement supérieure - un facteur de sécurité pour le cycliste qui sera d'autant plus visible.

**NL** - Voor extra comfort zijn veel fietsen uitgerust met verende en dempende onderdelen.

**En** - Many bikes are equipped with suspension, for your comfort.

**DE** - Zusätzlichen Komfort bietet bei vielen Modellen die Ausstattung mit federnden oder dämpfenden Teilen.

**FR** - Des nombreux modèles offrent un confort supplémentaire grâce aux pièces suspendues ou équipées d'amortisseur.

**NL** - Bij dubbel gebuste velgen zorgen de bussen voor een krachtenverdeling over een zo groot mogelijk oppervlak, hierdoor ontstaat een zeer sterk en duurzaam wiel, waardoor de kans op slagen in het wiel aanzienlijk minder groot wordt.

**EN** - In a double-eyeletted rim the spokes sit in special sleeves (eyelets). These eyelets ensure that the forces applied by the spoke are distributed across the largest possible area (both walls of the rim). This gives the wheel enormous strength and long life. The risk of a wobbly rim is minimal.

**DE** - Bei doppelt geösten Felgen sorgen die Ösen dafür, dass die einwirkenden Kräfte über eine möglichst große Oberfläche verteilt werden. Das Rad erhält dadurch mehr Stabilität und ist langlebiger. Das Risiko einer 'Acht' im Rad ist geringer.

**FR** - Sur les jantes à double oeillet, les rayons sont enserrés dans des oeillets spéciaux qui répartissent les forces exercées sur une surface maximale (des deux parois de la jante). La roue y gagne en stabilité et longévité. Le risque de voir une roue tordue 'en huit' est très minime.

|                           | <b>FullPro2Light</b>   | <b>FullProScandium</b>   | <b>Roadracer Ultegra</b>  | <b>RoadRacer Centaur</b>  | <b>RoadWinner Ultegra</b>  |
|---------------------------|--|--|---|---|--|
| <b>Frame sizes</b>        | 50-54-56-58-60-62cm  | 50-54-56-58-60-63  | 50-54-56-58-60-62cm   | 50-54-56-58-60-62cm   | 50-54-56-58-60-63-66cm   |
| <b>Weight ca.</b>         | 5,99 Kg  | 7,7 Kg   | 8,0 Kg  | 7,9 Kg  | 8,3 Kg   |
| <b>Price</b>              | € 6.999,0  | € 2.699,0  | € 2.299,0   | € 2.399,0   | € 1.899,0  |
| <b>Colour</b>             | visible carbon 1K  | Pearl white/NanoBlack  | visible carbon 3K/Pearl white   | visible carbon 3K/Pearl white   | Koga blue metallic/NanoBlack/Brush polish  |
| <b>Frame description</b>  | Ultra Lightweight FEM optimized carbon frame with Kevlar Protection System at chainstay and downtube. Built with Highmodulus carbon fiber and finished with a durable 1k PicoWeaveTech carbonfiber mesh. Equipped with integrated headset and a replaceable rear derailleur hanger | Completely hand-built super light Super Smooth TiG-welded frame. Tubes manufactured in triple-hardened and triple-buttet scandium. Equipped with integrated headset, engraved Koga rear-ends and a replaceable rear derailleur hanger. | Lightweight FEM optimized carbon frame with Kevlar Protection System at chainstay. Built with Highmodulus carbon fiber and finished with a durable 3k carbonfiber mesh. Equipped with integrated headset and a replaceable rear derailleur hanger | Lightweight FEM optimized carbon frame with Kevlar Protection System at chainstay. Built with Highmodulus carbon fiber and finished with a durable 3k carbonfiber mesh. Equipped with integrated headset and a replaceable rear derailleur hanger | Completely hand-built Super Smooth TiG-welded frame. Tubes manufactured in triple-hardened and exclusive tapered triple-buttet 7005 aluminium. Equipped with integrated headset, engraved Koga rear-ends and a replaceable rear derailleur hanger. |
| <b>Front fork</b>         | Koga - UltraLightweight PicoWeaveTech Highmodulus 1k mesh FEM optimized carbon   | Koga - Carbon 3k woven/Alloy   | Koga - Carbon 3k woven/Alloy  | Koga - Carbon 3k woven/Alloy  | Koga - Carbon 3k woven/Alloy   |
| <b>Headset</b>            | Ritchey Zero Pro Road Drop industrial bearing - Integrated in frame  | Tange Seiki industrial bearing - Integrated in frame   | Ritchey Zero Pro Road Drop industrial bearing - Integrated in frame   | Ritchey Zero Pro Road Drop industrial bearing - Integrated in frame   | Tange Seiki industrial bearing - Integrated in frame   |
| <b>Handlebar</b>          | 3T Rotundo LTD Lightweight Full Carbon - Traditional, medium-deep, round drop bend   | Ritchey ROAD WCS Logic II - Wet Black color  | Pro PLT Oversized alloy - Double Butted and Anatomic shape - Sand Blasted Black color   | FSA Omega Oversized alloy - Double Butted and ergonomic shape - Black color   | Pro PLT Oversized alloy - Double Butted and Anatomic shape - Sand Blasted Black color  |
| <b>Stem</b>               | 3T Arx LTD Lightweight Full Carbon - Titanium bolts  | Ritchey WCS 4-AXIS 84/6D - Wet Black color   | Pro PLT alloy - Sand Blasted Black color  | FSA OS-190 alloy - Carbon Front-cap - Black color   | Pro PLT alloy - Sand Blasted Black color   |
| <b>Handlebar tape</b>     | Koga extremely durable   | Koga extremely durable   | Koga extremely durable  | Koga extremely durable  | Koga durable black with white stitching  |
| <b>Brake (front)</b>      | Shimano Dura Ace   | Shimano Ultegra, Ice Grey color  | Shimano Ultegra, Ice Grey color   | Campagnolo Centaur Skeleton brakes  | Shimano Ultegra, Ice Grey color  |
| <b>Brake (rear)</b>       | Shimano Dura Ace   | Shimano Ultegra, Ice Grey Color  | Shimano Ultegra, Ice Grey Color   | Campagnolo Centaur Skeleton brakes  | Shimano Ultegra, Ice Grey Color  |
| <b>Shift-/Brake lever</b> | Shimano Dura Ace   | Shimano Ultegra, Ice Grey color  | Shimano Ultegra, Ice Grey color   | Campagnolo Centaur carbon   | Shimano Ultegra, Ice Grey color  |
| <b>Cables</b>             | Stainless steel inner cable -Flexible outer cable with teflon tube for light braking   | Stainless steel inner cable -Flexible outer cable with teflon tube for light braking   | Stainless steel inner cable -Flexible outer cable with teflon tube for light braking  | Stainless steel inner cable -Flexible outer cable with teflon tube for light braking  | Stainless steel inner cable -Flexible outer cable with teflon tube for light braking   |
| <b>Chain</b>              | Shimano Dura Ace   | Shimano Ultegra  | Shimano Ultegra   | Campagnolo Chorus   | Shimano Ultegra  |
| <b>Wheel set</b>          | FFWD F2R - Carbon tubular rims - DT Swiss 190 hubs with Ceramic bearings   | Shimano Ultegra, Ice Grey Color  | Mavic Aksium Black  | Campagnolo Khamсын  | Mavic Aksium Silver  |
| <b>Tires</b>              | Vredestein Fortezza Tri Comp 23mm - Sportex Protection Layer® - Curve Control System - Black color   | Vredestein Fortezza Tri Comp 23mm - Sportex Protection Layer® - Foldable - Anthracite/Red/Anthracite color   | Vredestein Fortezza Tri Comp 23mm - Sportex Protection Layer® - Foldable - Anthracite/Blue/Anthracite color   | Vredestein Fortezza Tri Comp 23mm - Sportex Protection Layer® - Foldable - Anthracite/Blue/Anthracite color   | Vredestein Fortezza Tri Comp 23mm - Sportex Protection Layer® - Foldable - Anthracite/Grey/Black color   |
| <b>Saddle</b>             | Selle Italia SLr Kit Carbonio - Lightweight Carbon rails   | Selle Italia SLR XP - Lorica lack black color  | Selle Italia C2 special edition   | Selle Italia C2 special edition   | Selle Italia C2 special edition  |
| <b>Seat post</b>          | 3T Doric LTD ø31,6x280mm Lightweight Full Carbon - Titanium bolts - No offset  | Ritchey WCS 2B ø31,6x300mm - Wet Black color   | Pro PLT ø31,6x280mm alloy - Sand Blasted Black color  | FSA SL 250 SBS ø31,6x280mm - Black color  | Pro PLT ø27,2x280mm alloy - Sand Blasted Black color   |
| <b>Seat clamp</b>         | Koga alloy   | Koga alloy   | Koga alloy  | Koga alloy  | Koga alloy   |
| <b>Crank set</b>          | Shimano Dura Ace Hollowtech II - UltraLightweight - Hyperdrive chainrings for smooth and precise shifting: 52x39T  | Shimano Ultegra Hollowtech II - UltraLightweight - Hyperdrive chainrings for smooth and precise shifting: 53x39T - Ice Grey color  | Shimano Ultegra Hollowtech II - UltraLightweight - Hyperdrive chainrings for smooth and precise shifting: 52x39x30T - Ice Grey color  | Campagnolo Centaur™ Ultra-Torque™ 53x39T Carbon   | Shimano Ultegra Hollowtech II - UltraLightweight - Hyperdrive chainrings for smooth and precise shifting: 52x39x30T - Ice Grey color   |
| <b>Bottom bracket</b>     | -  | -  | -   | Campagnolo Record™ Ultra-Torque™ - Overboard cups   | -  |
| <b>Pedals</b>             | -  | -  | -   | -   | -  |
| <b>Cassette</b>           | Shimano Dura Ace 10 speed - Hyperglide for quick and smooth shifting - Sprockets: 11-12-13-14-15-16-17-18-19-21T   | Shimano Ultegra 10 speed - Hyperglide for quick and smooth shifting - Sprockets: 12-13-14-15-16-17-19-21-23-25T  | Shimano Ultegra 10 speed - Hyperglide for quick and smooth shifting - Sprockets: 12-13-14-15-16-17-19-21-23-25T   | Campagnolo Centaur™ UD™ 10speed - Sprockets 12-13-14-15-16-17-19-21-23-25T  | Shimano Ultegra 10 speed - Hyperglide for quick and smooth shifting - Sprockets: 12-13-14-15-16-17-19-21-23-25T  |
| <b>Rear derailleur</b>    | Shimano Dura Ace   | Shimano Ultegra - Ice Grey Color   | Shimano Ultegra - Ice Grey Color  | Centaur - Carbon cage   | Shimano Ultegra - Ice Grey Color   |
| <b>Front derailleur</b>   | Shimano Dura Ace   | Shimano Ultegra - Ice Grey color   | Shimano Ultegra - Ice Grey color  | Centaur   | Shimano Ultegra - Ice Grey color   |
| <b>Gears</b>              | 20   | 20   | 30  | 20  | 30   |
| <b>Pump</b>               |  | SKS RoadRace - Softgrip  | SKS RoadRace - Softgrip   | SKS RoadRace - Softgrip   | SKS RoadRace - Softgrip  |
| <b>Bottle</b>             | Tacx Source Solid - Easy refill  | Tacx Source Solid - Easy refill  | Tacx Source Solid - Easy refill   | Tacx Source Solid - Easy refill   | Tacx Source Solid - Easy refill  |
| <b>Bottle holder</b>      | Elite Pase carbon  | Koga full carbon - Lightweight   | Koga full carbon - Lightweight  | Koga full carbon - Lightweight  | Elite Pase   |

Alle vermelde prijzen zijn adviesprijzen incl. BTW exclusief afleverkosten. Gewicht per fiets is gemeten bij gemiddelde framemaat, zonder pedalen, pomp, bindon(s), bidonhouder(s), bel en fietstas. Voor uitgebreide specificaties, zie onze website: [www.koga.com](http://www.koga.com). Koga B.V. behoudt zich het recht voor om zonder nadere kennisgeving wijzigingen in uitvoering(en) en/of prijzen aan te brengen. Ofschoon deze brochure met de grootst mogelijke zorg is samengesteld, kan geen aansprakelijkheid worden aanvaard voor eventuele onjuistheden van welke aard dan ook. Niets uit deze uitgave mag worden vermenigvuldigd zonder schriftelijke toestemming van KOGA B.V.

Alle angegebenen Preise sind empfohlene Verkaufspreise einschl. MwSt. exkl. Ablieferkosten. Gewicht des Fahrrads ist gemessen bei mittlerer Rahmengröße, ohne Pedale, Pumpe, Flasche(n) und Flaschenhalter, Glocke sowie Satteltasche. Ausführliche Spezifikationen finden Sie unter: [www.koga.com](http://www.koga.com). Koga B.V. behält sich vor, um ohne weitere Bekanntmachung Änderungen in den Spezifikationen und/oder Preisen durchzuführen. Obwohl diese Broschüre mit der größtmöglichen Sorgfalt zusammengestellt wurde, wird keine Haftung für eventuell vorkommende Unrichtigkeiten welcher Art dann auch übernommen. Vervielfältigungen aus dieser Ausgabe sind ohne schriftliche Einwilligung von KOGA B.V. nicht gestattet.

All prices are recommended retail prices including VAT exclusive delivery costs. Weight per bicycle is measured at an average frame size, without the pedals, pump, bottle(s) and holder(s), bell and saddle bag. For detailed specs: [www.koga.com](http://www.koga.com). Koga B.V. retains the right to make changes in specifications and/or prices without further notification. Although this brochure has been compiled with the greatest possible care, no liability can be accepted for any errors or any kind. Nothing from this publication may be duplicated without the written consent of KOGA B.V.

Tous les prix mentionnés sont des prix de vente conseillés, TVA comprise, hors livraison. Le poids par vélo est mesuré à une dimension de cadre moyenne, sans pédales, pompe, flacon(s) à boisson, porte(s)-flacon, sonnette et sacoché de selle. Pour des spécifications en détail: [www.koga.com](http://www.koga.com). KOGA B.V. se réserve le droit de procéder sans préavis à des modifications d'exécution(s) et/ou de prix. Bien que cette brochure ait été réalisée avec le plus grand soin possible, nous déclinons toutes responsabilités pour les éventuelles erreurs de quelque ordre qu'elles soient. Aucune partie de cette brochure ne doit être polycopiée sans l'accord écrit de KOGA B.V.



| RoadWinner 105   | Team Edition  | Flyer 105   | Flyer Tiagra  | CrossWinner   |
|--|---|---|---|---|
| 50-54-56-58-60-63-66cm   | 50-54-56-58-60-63-66cm  | 50-54-56-58-60-63-66cm  | 50-54-56-58-60-63-66cm  |   |
| 8,5 Kg<br>€ 1.699,0  | 8,7 Kg<br>€ 1.599,0   | 8,8 Kg<br>€ 1.399,0   | 9,0 Kg<br>€ 1.099,0   | 8,9 Kg<br>€ 1.399,0   |
| Koga blue metallic/NanoBlack/Brush polish  | Blue metallic/Pearl white/Solid black   | Electric red/Brush polish   | Electric red/Brush polish   | Brush polish/Solid black  |
| Completely hand-built Super Smooth TIG-welded frame. Tubes manufactured in triple-hardened and exclusive tapered triple-butted 7005 aluminium. Equipped with integrated headset, engraved Koga rear-ends and a replaceable rear derailleur hanger. | Completely hand-built Super Smooth TIG-welded frame. Tubes manufactured in triple-hardened and triple-butted 7005 aluminium. Equipped with integrated headset and a replaceable rear derailleur hanger. | Completely hand-built Super Smooth TIG-welded frame. Tubes manufactured in triple-hardened and triple-butted 7005 aluminium. Equipped with integrated headset and a replaceable rear derailleur hanger. | Completely hand-built Super Smooth TIG-welded frame. Tubes manufactured in triple-hardened and triple-butted 7005 aluminium. Equipped with integrated headset and a replaceable rear derailleur hanger. | Completely hand-built Super Smooth TIG-welded frame. Tubes manufactured in triple-hardened and triple-butted 7005 aluminium. Equipped with integrated headset and a replaceable rear derailleur hanger. |
| Koga - Carbon 3k woven/Alloy   | Koga - Carbon/Alloy   | Koga - Carbon/Alloy   | Koga - Carbon/Alloy   | Koga - Carbon 3k woven/Alloy  |
| Tange Seiki industrial bearing - Integrated in frame   | Ritchey Zero Logic ball bearing - Integrated in frame   | Tange Seiki industrial bearing - Integrated in frame  | Tange Seiki industrial bearing - Integrated in frame  | Tange Seiki industrial bearing - Integrated in frame  |
| Pro PLT Oversized alloy - Double Butted and Anatomic shape - Sand Blasted Black color  | Pro PLT Oversized alloy - Double Butted and Anatomic shape - Sand Blasted Black color   | Pro LT Oversized alloy - Double Butted and Anatomic shape - Sand Blasted Black color  | Pro LT Oversized alloy - Double Butted and Anatomic shape - Sand Blasted Black color  | Pro PLT Oversized alloy - Double Butted and Anatomic shape - Sand Blasted Black color   |
| Pro PLT alloy - Sand Blasted Black color   | Pro PLT alloy - Sand Blasted Black color  | Pro LT alloy - Sand Blasted Black color   | Pro LT alloy - Sand Blasted Black color   | Pro PLT alloy - Sand Blasted Black color  |
| Koga durable black with white stitching  | Koga extremely durable  | Koga extremely durable  | Koga extremely durable  | Koga extremely durable  |
| Shimano 105  | Shimano Ultegra, Ice Grey color   | Shimano 105   | Shimano Tiagra  | Tektro CR-520 - Stainless steel bolt - Anodized black   |
| Shimano 105  | Shimano Ultegra, Ice Grey Color   | Shimano 105   | Shimano Tiagra  | Tektro CR-520 - Stainless steel bolt - Anodized black   |
| Shimano 105  | Shimano Ultegra, Ice Grey color   | Shimano 105   | Shimano Tiagra  | Shimano 105   |
| Stainless steel inner cable -Flexible outer cable with teflon tube for light braking   | Stainless steel inner cable -Flexible outer cable with teflon tube for light braking  | Stainless steel inner cable -Flexible outer cable with teflon tube for light braking  | Stainless steel inner cable -Flexible outer cable with teflon tube for light braking  | Stainless steel inner cable -Flexible outer cable with teflon tube for light braking  |
| Shimano 105  | Shimano Ultegra   | Shimano 105   | Shimano Tiagra  | Shimano 105   |
| Mavic Aksium Silver  | Shimano RS-10   | Shimano RS-10   | Shimano RS-10   | Shimano RS-10   |
| Vredestein Fortezza Tri Comp 23mm - Sportex Protection Layer® - Foldable - Anthracite/Grey/Black color   | Michelin Speedium2 23mm - Foldable - Grey/Black color   | Vredestein Fortezza Tri Comp 23mm - Sportex Protection Layer® - Foldable - Anthracite/Grey/Black color  | Vredestein Fortezza Tri Comp 23mm - Sportex Protection Layer® - Foldable - Anthracite/Grey/Black color  | Schwalbe Racing Ralph Evolution 35mm - Triple compound - Foldable   |
| Selle Italia C2 special edition  | Selle Italia C2 special edition   | Selle Italia XR   | Selle Italia XR   | Selle Italia XR   |
| Pro PLT ø27,2x280mm alloy - Sand Blasted Black color   | Pro PLT ø27,2x280mm alloy - Sand Blasted Black color  | Pro XLT ø27,2x3000mm alloy - Sand Blasted Black color   | Pro XLT ø27,2x3000mm alloy - Sand Blasted Black color   | Pro PLT ø31,6x280mm alloy - Sand Blasted Black color  |
| Koga alloy   | Koga alloy  | Koga alloy  | Koga alloy  | Koga alloy  |
| Shimano 105 Hollowtech II - Ultralightweight - Hyperdrive chainrings for smooth and precise shifting: 50x39x30T - Silver color   | Shimano Ultegra Hollowtech II - Ultralightweight - Hyperdrive chainrings for smooth and precise shifting: 52x39x30T - Ice Grey color  | Shimano 105 Hollowtech II - Ultralightweight - Hyperdrive chainrings for smooth and precise shifting: 50x39x30T - Black color   | Shimano Tiagra Hollowtech II - Ultralightweight - Hyperdrive chainrings for smooth and precise shifting: 50x39x30T - Silver color   | FSA Gossamer MegaExo 46/36 T - black color  |
| -  | -   | -   | -   | -   |
| -  | -   | -   | -   | -   |
| Shimano 105 10 speed - Hyperglide for quick and smooth shifting - Sprockets: 12-13-14-15-16-17-19-21-23-25T  | Shimano Ultegra 10 speed - Hyperglide for quick and smooth shifting - Sprockets: 12-13-14-15-16-17-19-21-23-25T   | Shimano 105 10 speed - Hyperglide for quick and smooth shifting - Sprockets: 12-13-14-15-16-17-19-21-23-25T   | Shimano Tiagra 9 speed - Hyperglide for quick and smooth shifting - Sprockets: 12-13-14-15-17-19-21-23-25T  | Shimano 105 10 speed - Hyperglide for quick and smooth shifting - Sprockets: 12-13-14-15-16-17-19-21-23-25T   |
| Shimano 105  | Shimano Ultegra - Ice Grey Color  | Shimano 105   | Shimano Tiagra  | Shimano 105   |
| Shimano 105  | Shimano Ultegra - Ice Grey color  | Shimano 105   | Shimano Tiagra  | Shimano 105   |
| 30   | 30  | 30  | 27  | 20  |
| SKS RoadRace - Softgrip  | SKS RoadRace - Softgrip   | SKS RoadRace - Softgrip   | SKS RoadRace - Softgrip   | SKS RoadRace - Softgrip   |
| Tacx Source Solid - Easy refill  | Tacx Source Solid - Easy refill   | Tacx Source Solid - Easy refill   | Tacx Source Solid - Easy refill   | Tacx Source Solid - Easy refill   |
| Elite Pase   | Elite Pase  | Elite Pase  | Elite Pase  | Elite Pase  |

|                          | Kimera frame   | FullProTrack frame  |
|--------------------------|--|---|
| <b>Frame sizes</b>       | 54-57-60-63cm  | 53-56-59cm  |
| <b>Weight ca.</b>        | 1,9 Kg   | 1,4 Kg  |
| <b>Price</b>             | € 3.499,0  | € 899,0   |
| <b>Colour</b>            | visible carbon/Orange//  | Dutch orange metallic/Pearl white//   |
| <b>Frame description</b> | Ultra stiff FEM optimized carbon frame. Built with Highmodulus carbon fiber and finished with a durable 1k PicoWeaveTech carbonfiber mesh. Equipped with integrated headset. | Completely hand-built lightweight Super Smooth TIG-welded track frame. Tubes manufactured in triple-hardened and oval triple-butted scandium. Seat tube with special shape. Equipped with integrated headset and replaceable rear-ends. |
| <b>Front fork</b>        | Koga Track - Carbon/Alloy  | Koga Track - Carbon/Alloy   |
| <b>Shock</b>             | -  | -   |
| <b>Headset</b>           | Ritchey Zero WCS Road Drop industrial bearing - Integrated in frame  | Tange Seiki industrial bearing - Integrated in frame  |
| <b>Seat clamp</b>        | Koga alloy   | Koga alloy  |



|                                  | XPM-AM   | XPM-M  | XT Carbolite   | X-Runner   | X-Sport  |
|----------------------------------|--|--|--|--|--|
| <b>Frame sizes</b>               | 41-46-51-56cm  | 41-46-51-56cm  | 46-50-53 cm  | 41-46-51-56cm  | 41-46-51-56cm  |
| <b>Weight</b>                    | 12,4 Kg  | 12,2 Kg  | 9,9 Kg   | 10,9 Kg  | 11,3 Kg  |
| <b>Price</b>                     | € 2.799,0  | € 1.999,0  | € 2.999,0  | € 1.599,0  | € 1.199,0  |
| <b>Colour</b>                    | Trooper green  | Solid black  | Visible carbon   | Snow white metallic/Solid black  | Koga blue metallic/Solid black   |
| <b>Frame description</b>         | Completely hand-built lightweight TIG-welded full suspension frame. Tubes manufactured in triple-hardened and triple-butted 7005 aluminium. Equipped with integrated headset. New and improved Xtreme Pivot Management system, lightweight swing arm, equipped with air shock (travel 130 mm), replaceable rear derailleur hanger and Koga neoprene chainstay protector. | Completely hand-built lightweight TIG-welded full suspension frame. Tubes manufactured in triple-hardened and triple-butted 7005 aluminium. Equipped with integrated headset. New and improved Xtreme Pivot Management system, lightweight swing arm, equipped with air shock (travel 100 mm), replaceable rear derailleur hanger and Koga neoprene chainstay protector. | Lightweight T-700 Carbolite FEM optimized carbon frame. Built with Highmodulus carbon fiber and finished with a durable 3K carbonfiber mesh. Equipped with integrated headset, replaceable rear derailleur hanger and Koga neoprene chainstay protector. | Completely hand-built lightweight Super Smooth TIG-welded frame. Tubes manufactured in triple-hardened and triple-butted 7005 aluminium. Equipped with integrated headset. Seat and chain stays with S-bend shape, replaceable rear derailleur hanger and Koga neoprene chainstay protector. | Completely hand-built lightweight Super Smooth TIG-welded frame. Tubes manufactured in triple-hardened and triple-butted 7005 aluminium. Equipped with integrated headset. Seat and chain stays with S-bend shape, replaceable rear derailleur hanger and Koga neoprene chainstay protector. |
| <b>Front fork</b>                | Fox 32 Float RL - 140 mm travel - Lock Out - Rebound adjustment - White color  | Rockshox Reba SL - 100 mm travel - Lock Out - Rebound adjustment - Black color   | FOX 32 F 80 RL - 80 mm travel - Lock Out - Rebound adjustment - White color  | FOX 32 F 100 R - 100 mm travel - Rebound adjustment - White color  | Rockshox Tora 318 Solo Air - 100mm travel - Lock out - Rebound adjustment - White color  |
| <b>Shock</b>                     | Fastrax air ARL 190 - Rebound adjustment - Lock Out  | Fastrax air ARL 165 - Rebound adjustment - Lock Out  | -  | -  | -  |
| <b>Headset</b>                   | Tange Seiki industrial bearing - Integrated in frame   | Tange Seiki industrial bearing - Integrated in frame   | Tange Seiki industrial bearing - Integrated in frame   | Tange Seiki industrial bearing - Integrated in frame   | Tange Seiki industrial bearing - Integrated in frame   |
| <b>Handlebar</b>                 | Koga Oversized riserbar alloy - White color  | Ritchey Pro Mountain Straight Oversized alloy - Black color  | Ritchey Pro Mountain Straight Oversized alloy - Black color  | Ritchey Pro Mountain Straight Oversized alloy - Black color  | Ritchey Comp Mountain Straight Oversized alloy - Black color   |
| <b>Stem</b>                      | Koga Oversized - Lightweight 7075 T6 alloy - White color   | Ritchey Pro - Black color  | Ritchey Pro - Black color  | Ritchey Pro - Black color  | Ritchey Comp - Black color   |
| <b>Grips</b>                     | Koga Supergrrips with red anodized end caps  | Ritchey WCS Foam comfort grips   | Ritchey WCS Foam comfort grips   | Ritchey WCS Foam comfort grips   | Ritchey WCS Foam comfort grips   |
| <b>Brake (front)</b>             | -  | -  | -  | -  | Shimano Deore V-brake  |
| <b>Brake (rear)</b>              | -  | -  | -  | -  | Shimano Deore V-brake  |
| <b>Shift-/Brake lever</b>        | -  | -  | -  | -  | -  |
| <b>Shift lever</b>               | Shimano XT rapid fire plus - Two way and instant release - Optical gear display  | Shimano SLX rapid fire plus - Two way release - Removable Optical gear display   | Shimano XT rapid fire plus - Two way and instant release - Optical gear display  | Shimano SLX rapid fire plus - Two way release - Optical gear display   | Shimano Deore rapid fire plus with optical gear display  |
| <b>Brake lever</b>               | -  | -  | -  | -  | Shimano Deore  |
| <b>Disc-/Hydraulic brake set</b> | Shimano XT with Reach and Free stroke adjustment   | Shimano SLX with Tool Free Reach adjustment  | Shimano XT with Reach and Free stroke adjustment   | Shimano BRM486 - Twin Piston technique - Increased life time resin pad   | -  |
| <b>Cables</b>                    | -  | -  | -  | -  | Stainless steel inner cable -Flexible outer cable with teflon tube for light braking   |
| <b>Rotor front</b>               | Shimano XT SMRT-79 ø180 mm   | Shimano SMRT-64 ø180 mm  | Shimano XT SMRT-79 ø160 mm   | Shimano ø160 mm  | -  |
| <b>Rotor rear</b>                | Shimano XT SMRT-79 ø180 mm   | Shimano SMRT-64 ø160 mm  | Shimano XT SMRT-79 ø160 mm   | Shimano ø160 mm  | -  |
| <b>Chain</b>                     | Shimano XT Hyperglide for smooth shifting and riding - Neoprene Chainstay protector  | Shimano SLX Hyperglide for smooth shifting and riding  | Shimano XT Hyperglide for smooth shifting and riding   | Shimano SLX Hyperglide for smooth shifting and riding  | Shimano Deore Hyperglide for smooth shifting and riding  |
| <b>Wheel set</b>                 | -  | -  | Shimano XT lightweight   | -  | -  |
| <b>Front hub</b>                 | Shimano XT lightweight   | Shimano SLX - Double contact sealing for low maintenance and increased service life  | -  | Shimano SLX - Double contact sealing for low maintenance and increased service life  | Shimano Deore - Internal grease sleeve for increased service life  |
| <b>Rear hub</b>                  | -  | Shimano SLX - Double contact sealing for low maintenance and increased service life  | -  | Shimano SLX - Double contact sealing for low maintenance and increased service life  | Shimano Deore - Internal grease sleeve for increased service life  |
| <b>Tires</b>                     | Schwalbe Nobby Nic Evolution 2.25 - Triple compound - Foldable   | Schwalbe Racing Ralph Evolution 2.25 - Triple compound - Foldable  | Schwalbe Racing Ralph Evolution 2.1 - Triple compound - Foldable   | Schwalbe Racing Ralph Evolution 2.1 - Triple compound - Foldable   | Schwalbe Racing Ralph Evolution 2.1 - Triple compound - Foldable   |
| <b>Rims</b>                      | -  | Mavic XM 317 Disc - Black color  | -  | Mavic XM 317 Disc - Black color  | Mavic XM 317 - Black color   |
| <b>Spokes</b>                    | -  | Sapim stainless - Cold forged reinforced - Black color   | -  | Sapim stainless - Cold forged reinforced - Black color   | Sapim stainless - Cold forged reinforced - Black color   |
| <b>Saddle</b>                    | Fi'zi:k Zeak - Magnesium rail - Black/Green color  | Selle Italia XR Light  | Selle Italia XR  | Selle Italia XR Light  | Selle Italia XR  |
| <b>Seat post</b>                 | Ritchey Comp Mountain ø31,6x400mm alloy - Black color  | Ritchey Pro Mountain ø31,6x400mm alloy - Black color   | Ritchey Pro Mountain ø31,6x400mm alloy - Black color   | Ritchey Pro Mountain ø31,6x400mm alloy - Black color   | Ritchey Comp Mountain ø31,6x400mm alloy - Black color  |
| <b>Seat clamp</b>                | Koga alloy QR  | Koga alloy   | Koga alloy   | Koga alloy   | Koga alloy   |
| <b>Crank set</b>                 | Shimano XT Hollowtech II - Ultra-Lightweight - Hyperdrive chainrings for smooth and precise shifting: 44x32x22T - Silver color   | Shimano SLX Hollowtech II - Ultra-Lightweight - Hyperdrive chainrings for smooth and precise shifting: 44x32x22T - Silver color  | Shimano XT Hollowtech II - Ultra-Lightweight - Hyperdrive chainrings for smooth and precise shifting: 44x32x22T - Silver color   | Shimano SLX Hollowtech II - Ultra-Lightweight - Hyperdrive chainrings for smooth and precise shifting: 44x32x22T - Silver color  | Shimano special Deore with alloy middle chainring Hollowtech II - UltraLightweight - Hyperdrive chainrings for smooth and precise shifting: 44x32x22T - Silver color   |
| <b>Pedals</b>                    | -  | -  | -  | -  | -  |
| <b>Cassette</b>                  | Shimano XT 9 speed - Hyperglide for quick and smooth shifting - Sprockets: 11-12-14-16-18-21-24-28-32T   | Shimano SLX HG-80 9 speed - Hyperglide for quick and smooth shifting - Sprockets: 11-12-14-16-18-21-24-28-32T  | Shimano XT 9 speed - Hyperglide for quick and smooth shifting - Sprockets: 11-12-14-16-18-21-24-28-32T   | Shimano SLX HG-80 9 speed - Hyperglide for quick and smooth shifting - Sprockets: 11-12-14-16-18-21-24-28-32T  | Shimano Deore HG-61 9 speed - Hyperglide for quick and smooth shifting - Sprockets: 11-12-14-16-18-21-24-28-32T  |
| <b>Rear derailleur</b>           | Shimano XT shadow - Low profile design for more aggressive riding  | Shimano SLX shadow - Low profile design for more aggressive riding   | Shimano XT shadow - Low profile design for more aggressive riding  | Shimano SLX shadow - Low profile design for more aggressive riding   | Shimano Deore  |
| <b>Front derailleur</b>          | Shimano XT   | Shimano Deore SLX  | Shimano XT   | Shimano SLX  | Shimano Deore  |
| <b>Gears</b>                     | 27   | 27   | 27   | 27   | 27   |
| <b>Pump</b>                      | -  | -  | Koga Telescopic with alloy barrel - Schrader and Presta fit - High Pressure/ Big Volume switch - Ergonomic hinge grip  | Koga Telescopic with alloy barrel - Schrader and Presta fit - High Pressure/ Big Volume switch - Ergonomic hinge grip  | Koga Telescopic with alloy barrel - Schrader and Presta fit - High Pressure/ Big Volume switch - Ergonomic hinge grip  |
| <b>Bottle</b>                    | Tacx Source Solid - Easy refill  | Tacx Source Solid - Easy refill  | Tacx Source Solid - Easy refill  | Tacx Source Solid - Easy refill  | Tacx Source Solid - Easy refill  |
| <b>Bottle holder</b>             | Elite Pase   | Zefal Wiiz   | Koga full carbon - Lightweight   | Elite Pase   | Elite Pase   |



|                     | WorldTraveller  | Randonneur (G) / (M)  | Traveller (G) / (M)  |
|---------------------|---|---|--|
| Frame sizes         | 50-54-57-60cm   | G: 50-54-57-60-63cm<br>M: 47-50-53-56   | G: 50-54-57-60-63-66cm<br>M: 47-50-53-56cm   |
| Weight              | 15,7 Kg   | 17,3 Kg   | 16,6 Kg  |
| Price               | € 1.999,0   | € 1.899,0   | € 1.699,0  |
| Colour              | Anthracite grey metallic  | Siennablack Metallic  | Grey metallic  |
| Frame description   | Completely hand-built Super Smooth TIG-welded 26" frame. Tubes manufactured in triple-hardened and triple-buffed 7005 aluminium. Top- and down tube oval and super oversized for extra stability. Equipped with integrated headset, base-ments for all accessories, integrated kick-stand, disc brake connection in rear-end, and a replaceable rear derailleur hanger. | Completely classic hand-built lugged frame. Tubes manufactured in oval double-buffed Koga Miyata FM-1 chromium-molybdenum. Equipped with engraved lugs and bracket unit and base-ments for all accessories. | Completely hand-built Super Smooth TIG-welded frame. Tubes manufactured in triple-hardened and oval oversized triple-buffed 7005 aluminium. Down tube with integrated shifter cables. Equipped with integrated headset, base-ments for all accessories, integrated kickstand, disc brake connection in rear-end, and a replaceable rear derailleur hanger. |
| Front fork          | Chromo-Alloy  | Chromo-Alloy  | Chromo-Alloy   |
| Headset             | Tange Seiki industrial bearing - Integrated in frame  | Tange Seiki ball bearing  | Tange Seiki industrial bearing - Integrated in frame   |
| BrakePowerControl   | Yes   | Yes   | Yes  |
| Handlebar           | Pro double butted alloy - Sand Blasted Black color  | Koga Multigrip - Ergonomic multiposition handlebar - Black color  | Koga Multigrip - Ergonomic multiposition handlebar - Black color   |
| Stem                | ITM Trekking alloy - adjustable - quill ø25,4 - Black color   | ITM Trekking alloy - adjustable - quill ø22,2 - Black color   | ITM Trekking alloy - adjustable - quill ø25,4 - Black color  |
| Grips               | Ergon with integrated bar ends  | Koga Genuine Leather Multigrip  | Koga Genuine Leather Multigrip   |
| Brake               | Shimano XT V-brake  | Shimano LX V-brake  | Shimano LX V-brake   |
| Shift lever         | Shimano XT rapid fire plus - Two way and instant release - Optical gear display   | Shimano Deore LX rapid fire plus - Two way release - Optical gear display   | Shimano Deore LX rapid fire plus - Two way release - Optical gear display  |
| Brake lever         | Shimano XT  | Shimano LX  | Shimano LX   |
| Cables              | Stainless steel inner cable -Flexible outer cable with teflon tube for light braking  | Stainless steel inner cable -Flexible outer cable with teflon tube for light braking  | Stainless steel inner cable -Flexible outer cable with teflon tube for light braking   |
| Chain               | Shimano Deore LX Hyperglide for smooth shifting and riding  | Shimano Deore LX Hyperglide for smooth shifting and riding  | Shimano Deore LX Hyperglide for smooth shifting and riding   |
| Front hub           | Shimano XT - Double contact sealing for low maintenance and increased service life  | Shimano DH-3N72 6V/3,0W - Lightweight sporthub - Low rotating friction - Quick Release  | Shimano DH-3N71 6V/3,0W - Light-weight sporthub - Low rotating friction - Quick Release  |
| Rear hub            | Shimano XT - Double contact sealing for low maintenance and increased service life  | Shimano XT - Double contact sealing for low maintenance and increased service life  | Shimano Deore LX - Double contact sealing for low maintenance and increased service life   |
| Tires               | Continental TravelContact 47mm - Kevlar protection - Duraskin side protection - Side reflection   | Schwalbe Marathon 37mm - Kevlar Guard and S-skin side protection - Side reflection  | Schwalbe Marathon 37mm - Kevlar Guard and S-skin side protection - Side reflection   |
| Rims                | Koga KM21-559 alloy - Double wall and double eyeletted 36 holes - Durable finished - Black color  | Koga KM21-622 alloy - Double wall and double eyeletted 36/40 holes - Durable finished - Titan color   | Koga KM21-622 alloy - Double wall and double eyeletted 36 holes - Durable finished - Black color   |
| Spokes              | Sapim stainless - Cold forged reinforced  | Sapim stainless - Cold forged reinforced  | Sapim stainless - Cold forged reinforced   |
| Saddle              | Brooks Flyer including Brooks maintenance set - Black color   | Selle Italia FLX Man - Genuine full grain leather   | Selle Italia FLX Man - Genuine full grain leather  |
| Seat post           | Ritchey Comp Mountain ø31,6x400mm alloy - Black color   | Post Moderne alloy - Shock absorbing - Safety Clamp construction - Travel 30mm - Black color  | Satori alloy - Safety Clamp construction - Black color   |
| Seat clamp          | Koga alloy  | -   | Koga alloy   |
| Crank set           | Shimano XT Hollowtech II with Chain-guide - UltraLightweight - Hyperdrive chainrings for smooth and precise shifting: 44x32x22T - Silver color  | Shimano Deore LX Hollowtech II with Chainguide - UltraLightweight - Hyperdrive chainrings for smooth and precise shifting: 48x36x26T - Silver color   | Shimano special Deore with alloy middle chainring Hollowtech II - UltraLightweight - Hyperdrive chainrings for smooth and precise shifting: 48x36x26T - Silver color   |
| Pedals              | Multipurpose pedal: SPD side and platform side  | Multipurpose pedal: SPD side and platform side  | Koga VP-191 alloy - Industrial bearing - Anti slip layer   |
| Cassette            | Shimano XT 9 speed - Hyperglide for quick and smooth shifting - Sprockets: 11-12-14-16-18-21-24-28-32T  | Shimano Deore LX HG-80 9 speed - Hyperglide for quick and smooth shifting - Sprockets: 11-12-14-16-18-21-24-28-32T  | Shimano Deore LX HG-80 9 speed - Hyperglide for quick and smooth shifting - Sprockets: 11-12-14-16-18-21-24-28-32T   |
| Rear derailleur     | Shimano XT  | Shimano XT  | Shimano Deore LX   |
| Front derailleur    | Shimano XT  | Shimano Deore LX  | Shimano Deore LX   |
| Gears               | 27  | 27  | 27   |
| Derailleur guard    | Koga stainless steel  | Koga stainless steel  | Koga stainless steel   |
| Pump                | Topeak Roadmorph Small - Frame mounted floor pump - Ergonomic hinge grip  | Topeak Roadmorph Small - Frame mounted floor pump - Ergonomic hinge grip  | Koga Telescopic with alloy barrel - Schra-der and Presta fit - High Pressure/ Big Volume switch - Ergonomic hinge grip   |
| Bottle              | Koga alloy 2x - Hygienic innerlayer - Easy refill - Silver color  | Koga alloy 2x - Hygienic innerlayer - Easy refill - Titan color   | Koga alloy 2x - Hygienic innerlayer - Easy refill - Silver color   |
| Bottle holder       | Zefal Wiiz  | Elite Taki 2x   | Elite Taki 2x  |
| Bell                | Witek Decibel II with compass - Black color   | Witek Decibel II with compass - Black color   | Witek Decibel II with compass - Black color  |
| Chain guard         | -   | -   | -  |
| Mudguard (f)        | SKS P-50 - Black/Silver color   | SKS P-45 - Titan color  | SKS P-45 - Black/Silver color  |
| Mudguard (r)        | SKS P-50 - Black/Silver color   | SKS P-50 - Integrated rear light wiring - Titan color   | SKS P-50 - Integrated rear light wiring - Black/Silver color   |
| Headlight           | Cateye HLEL135 - Opticube lens technol-ogy with wide beam pattern - Batteries included  | Koga Rayo Senso+ - New IQ-LED technol-ogy 32 Lux - Standlight function - Integrated reflector - KBA approved -Black color   | Koga Rayo Senso+ - New IQ-LED technology 32 Lux - Standlight function - Integrated reflector - KBA approved -Black color   |
| Rear light          | B&M DToplight XS senso - Long life LED technology - Battery included - KBA approved   | B&M 4DToplight multi senso - Long life LED technology - Battery and Dynamo mode - KBA approved - Black color  | B&M 4DToplight multi senso - Long life LED technology - Battery and Dynamo mode - KBA approved - Black color   |
| Dynamo              | -   | Hub   | Hub  |
| Rear carrier        | Tabus Logo - Steel tubing max 40 kg - High/Low bag position - Durable black powdercoated finish - 10 years guarantee  | Tabus Logo - Steel tubing max 40 kg - High/Low bag position - Durable black powdercoated finish - 10 years guarantee  | Tabus Logo - Steel tubing max 40 kg - High/Low bag position - Durable black powdercoated finish - 10 years guarantee   |
| Low-rider           | Tabus Ergo - Steel tubing max 15 kg - Durable black powdercoated finish - 10 years guarantee  | Tabus Ergo - Steel tubing max 15 kg - Durable black powdercoated finish - 10 years guarantee  | Tabus Ergo - Steel tubing max 15 kg - Durable black powdercoated finish - 10 years guarantee   |
| Low-rider kickstand | Koga - Stability under wind or weight load - Black color  | Koga - Stability under wind or weight load - Black color  | Koga - Stability under wind or weight load - Black color   |
| Rubber strap        | Witek Triobinder T - Black color  | Witek Triobinder T - Black color  | Witek Triobinder T - Black color   |
| Kickstand           | Pletscher Comp - Superb stability - Powdercoated durable finish - Black color   | Pletscher Multi - Superb stability - Powder-coated durable finish - Titan color   | Pletscher Comp - Superb stability - Pow-dercoated durable finish - Black color   |
| Ring lock           | AXA Defender RL - ART ** approved - Folding key - Black color   | AXA Defender RL - ART ** approved - Folding key - Titan/Black color   | AXA Defender RL - ART ** approved - Folding key - Black color  |
| Saddlebag           | Koga Medium with straps   | Koga Medium with click fix system   | Koga Medium with click fix system  |



|                                  | TerraLinerAlloy   | RoadChamp   | SportsLady   | TerraLinerCarbolite  | LightDeluxe (G/M)   |
|----------------------------------|---|---|--|--|---|
| <b>Frame sizes</b>               | 47-50-54-57-60-63cm   | 52-54-56-58-60-63cm   | 47-50-53-56cm  | 50-54-57-60  | G: 50-54-57-60-63<br>M: 47-50-53-56cm   |
| <b>Weight</b>                    | 11,3 Kg   | 9,2 Kg  | 9,9 Kg   | 10,8 Kg  | 11,9 Kg   |
| <b>Price</b>                     | € 1.299,0   | € 1.199,0   | € 1.199,0  | € 2.299,0  | € 1.699,0   |
| <b>Colour</b>                    | Koga black metallic/NanoBlack/Brush polish  | High-tech grey metallic/Koga black metallic   | Waterfall blue metallic/NanoBlack  | Visible carbon 3K  | Solid black/High polish   |
| <b>Frame description</b>         | Completely hand-built Super Smooth TiG-welded frame. Tubes manufactured in triple-hardened and exclusive tapered triple-butted 7005 aluminium. Down tube with integrated shifter cable. Equipped with integrated headset and baseaments for all accessories, disc brake connection in rear-end, and a replaceable rear derailleur hanger. | Completely hand-built Super Smooth TiG-welded frame. Tubes manufactured in triple-hardened and "eight shape" triple-butted 7005 aluminium. Equipped with integrated headset and baseaments point for mudguard and carrier and a replaceable rear derailleur hanger. | Completely hand-built Super Smooth TiG-welded special "mixed shape" frame. Tubes manufactured in triple-hardened and slightly oversized 7005 aluminium. Equipped with integrated headset and baseaments for mudguard and carrier and a replaceable rear derailleur hanger. | Lightweight FEM optimized carbon frame. Built with Highmodulus carbon fiber and finished with a durable 3k carbonfiber mesh. Down tube with integrated shifter cable. Equipped with integrated headset, baseaments for all accessories and a replaceable rear derailleur hanger. | Completely hand-built Super Smooth TiG-welded semi sloping frame. Tubes manufactured in triple-hardened and oval triple-butted 7005 aluminium. Down tube with integrated shifter cable. Equipped with integrated headset and baseaments for all accessories and a replaceable rear derailleur hanger. |
| <b>Front fork</b>                | SR Suntour SF9-NCXD Ultra light Magnesium - Travel 50mm - Lock-out  | Carbon-Chromo   | Carbon-Chromo  | Koga - Carbon/Alloy 3K woven   | Carbon-Alloy  |
| <b>Headset</b>                   | Ritchey Zero Pro Road Drop industrial bearing - Integrated in frame   | Tange Seiki ball bearing - Integrated in frame  | Tange Seiki ball bearing - Integrated in frame   | Tange Seiki industrial bearing - Integrated in frame   | Tange Seiki industrial bearing - Integrated in frame  |
| <b>BrakePowerControl</b>         | -   | Yes   | Yes  | Yes  | Yes   |
| <b>Handlebar</b>                 | Ritchey Mountain Straight Oversized alloy - Black color   | Pro Fitness double butted alloy - Sand Blasted Black color  | Pro Fitness double butted alloy - Sand Blasted Black color   | Koga Oversized riserbar alloy - Sand Blasted Black color   | Koga Oversized riserbar alloy - Sand Blasted Black color  |
| <b>Stem</b>                      | Ritchey Mountain - Black color  | Pro Fitness alloy - adjustable - quill ø25,4 - Sand Blasted Black color   | Pro Fitness alloy - adjustable - quill ø25,4 - Sand Blasted Black color  | Koga carbon wrap - Oversized   | Koga Oversized - Lightweight 6061 T6 alloy - Sand Blasted Black color   |
| <b>Grips</b>                     | Ritchey WCS Foam comfort grips  | Ritchey WCS Foam comfort grips  | Ritchey WCS Foam comfort grips   | Koga Genuine Leather soft grip with special Blue stitching   | Koga Genuine Leather soft grip with brown stitching   |
| <b>Brake Shift lever</b>         | Shimano Deore V-rimbrake<br>Shimano Deore rapid fire plus - Two way release - Optical gear display  | Shimano Tiagra<br>Shimano Flat handlebar type   | Shimano Tiagra<br>Shimano Flat handlebar type  | Shimano XT V-rimbrake<br>Shimano XT rapid fire plus - Two way and instant release - Optical gear display   | Shimano XT V-rimbrake<br>Shimano XT rapid fire plus - Two way and instant release - Optical gear display  |
| <b>Brake lever</b>               | Shimano Deore   | Shimano Flat handlebar type   | Shimano Flat handlebar type  | Shimano XT   | Shimano XT  |
| <b>Disc-/Hydraulic brake set</b> | -   | -   | -  | -  | -   |
| <b>Cables</b>                    | Stainless steel inner cable -Flexible outer cable with teflon tube for light braking  | Stainless steel inner cable -Flexible outer cable with teflon tube for light braking  | Stainless steel inner cable -Flexible outer cable with teflon tube for light braking   | Stainless steel inner cable -Flexible outer cable with teflon tube for light braking   | Stainless steel inner cable -Flexible outer cable with teflon tube for light braking  |
| <b>Chain</b>                     | Shimano Deore LX Hyperglide for smooth shifting and riding  | Shimano Deore Hyperglide for smooth shifting and riding   | Shimano Deore Hyperglide for smooth shifting and riding  | Shimano XT Hyperglide for smooth shifting and riding   | Shimano XT Hyperglide for smooth shifting and riding  |
| <b>Wheel set</b>                 | -   | Shimano WH-R500   | Shimano WH-R500  | -  | -   |
| <b>Front hub</b>                 | Shimano DH-3N80 6V/3,0W - Lightweight sporthub - Low rotating friction - Quick Release  | -   | -  | Shimano DH-3N80 6V/3,0W - Lightweight sporthub - Low rotating friction - Quick Release   | Shimano DH-3N80 6V/3,0W - Lightweight sporthub - Low rotating friction - Quick Release  |
| <b>Rear hub</b>                  | Shimano XT - Double contact sealing for low maintenance and increased service life  | -   | -  | Shimano XT - Double contact sealing for low maintenance and increased service life   | Shimano XT - Double contact sealing for low maintenance and increased service life  |
| <b>Tires</b>                     | Continental Double Fighter 37mm - Foldable - Black color  | Vredestein Fortezza 25mm - Sportex Protection Layer® - Foldable - Black color   | Vredestein Fortezza 25mm - Sportex Protection Layer® - Foldable - Black color  | Schwalbe Marathon Racer 35mm - RaceGuard: puncture protection/low rolling resistance - Foldable - Side reflection  | Schwalbe Marathon Racer 35mm - RaceGuard: puncture protection/low rolling resistance - Side reflection  |
| <b>Rims</b>                      | Exal LX17-622 alloy - Double wall and double eyeletted 32 holes - Durable finished - Black color  | -   | -  | Exal XR3 622 alloy - Single eyeletted 32 holes - Durable finished -Black color   | Exal LX17-622 alloy - Double wall and double eyeletted 32 holes - Durable finished - Black color  |
| <b>Spokes</b>                    | Sapim stainless - Cold forged reinforced - Black color  | -   | -  | Sapim stainless - Cold forged reinforced - Black color   | Sapim stainless - Cold forged reinforced - Black color  |
| <b>Saddle</b>                    | Selle Royal viper - Scuff guards  | Fi'zi:k Rondine - Wingflex system - Black/Silver/Red color  | Fi'zi:k Rondine - Wingflex system - Black/Silver/Red color   | Fi'zi:k Rondine - Wingflex system - Black/Silver/Blue color  | Fi'zi:k Rondine - Wingflex system - Black/Silver/Brown color  |
| <b>Seat post</b>                 | Satori alloy - Safety Clamp construction - Black color  | Pro Fitness ø27,2x270mm alloy - Sand Blasted Black color  | Pro Fitness ø27,2x270mm alloy - Sand Blasted Black color   | Koga carbon 31.6x300   | Koga ø31,6x350mm - Lightweight 7075 T6 alloy - Sand Blasted Black color   |
| <b>Seat clamp</b>                | Koga alloy  | Koga alloy  | Koga alloy   | Koga alloy   | Koga alloy  |
| <b>Crank set</b>                 | Shimano special Deore with alloy outer and middle chainring Hollowtech II - UltraLightweight - Hyperdrive chainrings for smooth and precise shifting: 44x32x22T - Silver color  | Shimano Tiagra Hollowtech II - Ultra-Lightweight - Hyperdrive chainrings for smooth and precise shifting: 50x39x30T - Silver color  | Shimano Tiagra Hollowtech II - Ultra-Lightweight - Hyperdrive chainrings for smooth and precise shifting: 50x39x30T - Silver color   | Shimano XT Hollowtech II with Chainguide - UltraLightweight - Hyperdrive chainrings for smooth and precise shifting: 48x36x26T - Silver color  | Shimano XT Hollowtech II with Chainguide - UltraLightweight - Hyperdrive chainrings for smooth and precise shifting: 48x36x26T - Silver color   |
| <b>Bottom bracket</b>            | -   | -   | -  | -  | -   |
| <b>Pedals</b>                    | Multipurpose pedal: SPD side and platform side  | Multipurpose pedal: SPD side and platform side  | Multipurpose pedal: SPD side and platform side   | Koga VP-191 alloy - Industrial bearing - Anti slip layer   | Koga VP-191 alloy - Industrial bearing - Anti slip layer  |
| <b>Cassette</b>                  | Shimano HG-80 Deore LX 9 speed - Hyperglide for quick and smooth shifting - Sprockets: 11-12-13-14-16-18-21-24-28T  | Shimano Tiagra 9 speed - Hyperglide for quick and smooth shifting - Sprockets: 12-13-14-15-17-19-21-23-25T  | Shimano Tiagra 9 speed - Hyperglide for quick and smooth shifting - Sprockets: 12-13-14-15-17-19-21-23-25T   | Shimano Ultegra 9 speed - Hyperglide for quick and smooth shifting - Sprockets: 12-13-14-15-17-19-21-23-25T  | Shimano Ultegra 9 speed - Hyperglide for quick and smooth shifting - Sprockets: 12-13-14-15-17-19-21-23-25T   |
| <b>Rear derailleur</b>           | Shimano XT  | Shimano Tiagra  | Shimano Tiagra   | Shimano XT   | Shimano XT  |
| <b>Front derailleur</b>          | Shimano XT  | Shimano Tiagra  | Shimano Tiagra   | Shimano XT   | Shimano XT  |
| <b>Gears</b>                     | 27  | 27  | 27   | 27   | 27  |
| <b>Derailleur guard</b>          | -   | -   | -  | -  | -   |
| <b>Pump</b>                      | Koga Telescopic with alloy barrel - Schrader and Presta fit - High Pressure/ Big Volume switch - Ergonomic hinge grip   | Koga Telescopic with alloy barrel - Schrader and Presta fit - High Pressure/ Big Volume switch - Ergonomic hinge grip   | Koga Telescopic with alloy barrel - Schrader and Presta fit - High Pressure/ Big Volume switch - Ergonomic hinge grip  | Koga Rookie XL Special - Ergonomic hinge grip  | Koga Rookie XL Special - Ergonomic hinge grip   |
| <b>Bell</b>                      | -   | -   | -  | Widek Compact  | Widek Compact   |
| <b>Chain guard</b>               | -   | -   | -  | -  | -   |
| <b>Mudguard (f)</b>              | -   | -   | -  | Curana Liteweight Hylite - Black color   | SKS P-45 - Black/Silver color   |
| <b>Mudguard (r)</b>              | -   | -   | -  | Curana Liteweight Hylite - Black color   | SKS P-45 - Integrated rear light wiring - Black/Silver color  |
| <b>Coat guards</b>               | -   | -   | -  | -  | -   |
| <b>Headlight</b>                 | -   | -   | -  | B&M Lumotec IQ Cyo senso plus - New IQ Long life LED technology 40 Lux - Standlight function - KBA approved - Black color  | B&M Fly senso - Long life LED technology - KBA approved - Black/Silver color  |
| <b>Rear light</b>                | -   | -   | -  | B&M Toplight Flat plus - Long life LED technology - Lightweight - Standlight function - KBA approved - Black color   | B&M Toplight Flat plus - Long life LED technology - Lightweight - Standlight function - KBA approved - Black color  |
| <b>Dynamo</b>                    | -   | -   | -  | Hub  | Hub   |
| <b>Rear carrier</b>              | -   | -   | -  | Hub  | Hub   |
| <b>Kickstand</b>                 | -   | -   | -  | Hub  | Hub   |
| <b>Saddlebag</b>                 | Fi'zi:k Small ICS click system  | Fi'zi:k Small ICS click system  | Fi'zi:k Small ICS click system   | Hub<br>Tubus Fly - Steel tubing max 18 kg - Durable black powdercoated finish - 10 years guarantee   | Hub<br>Tubus Vega - Steel tubing max 25 kg - Durable black powdercoated finish - 10 years guarantee   |
|                                  |   |   |  | Atran Stylo Adjustable - Superb stability - Powdercoated durable finish - Black color  | Atran Stylo Adjustable - Superb stability - Powdercoated durable finish - Black color   |

| RoadRunner (G/M)  | RoadSpeed (G/L)   | LightRunner (G/M)   | LightSpeed (G/L)  |
|---|---|---|---|
| G: 47-50-54-57-60-63cm<br>M: 47-50-53-56cm  | G: 50-54-57-60-63cm<br>L: 47-50-53-56cm   | G: 50-54-57-60-63cm<br>M: 47-50-53-56cm   | G: 50-54-57-60-63-66cm<br>L: 47-50-53-56-59cm   |
| 13,9 Kg<br>€ 1.499,0  | 13,9 Kg<br>€ 1.399,0  | 13,6 Kg<br>€ 1.399,0  | 13,6 Kg<br>€ 1.299,0  |
| Koga black metallic/NanoBlack/Brush polish  | Deep blue metallic/Brush polish   | Blue metallic/Anthracite grey metallic  | Winning silver/NanoBlack  |
| Completely hand-built Super Smooth TIG-welded frame. Tubes manufactured in triple-hardened and oval triple-buttet 7005 aluminium. Equipped with integrated headset and basements for all accessories, and a replaceable rear derailleur hanger. | Completely hand-built Super Smooth TIG-welded Twin Tube frame. Tubes manufactured in triple-hardened 7005 aluminium. Equipped with integrated headset and basements for all accessories and a replaceable rear derailleur hanger. | Completely hand-built Super Smooth TIG-welded frame. Tubes manufactured in triple-hardened and oval triple-buttet 7005 aluminium. Equipped with integrated headset and basements for all accessories, and a replaceable rear derailleur hanger. | Completely hand-built Super Smooth TIG-welded Twin Tube frame. Tubes manufactured in triple-hardened 7005 aluminium. Equipped with integrated headset and basements for all accessories and a replaceable rear derailleur hanger. |
| Koga Feather - Lightweight - Ball bearing guided suspension fork - Travel 35 mm   | Koga Feather - Lightweight - Ball bearing guided suspension fork - Travel 35 mm   | Chromo-Alloy  | Chromo-Alloy  |
| Tange Seiki ball bearing -Integrated in frame   | Tange Seiki ball bearing -Integrated in frame   | Tange Seiki ball bearing -Integrated in frame   | Tange Seiki ball bearing -Integrated in frame   |
| Yes   | -   | Yes   | -   |
| Koga Dali alloy - Ergonomic sportive multiposition handlebar - Black color  | ITM The Bird alloy - Lightweight - Black color  | Koga Dali alloy - Ergonomic sportive multiposition handlebar - Black color  | ITM The Bird alloy - Lightweight - Black color  |
| Koga adjustable stem - A-head - Black color   | Koga adjustable stem - A-head - Black color   | Koga adjustable stem - A-head - Black color   | ITM Trekking alloy - adjustable - quill ø25,4 - Black color   |
| Koga Genuine Leather Multigrip  | Koga Genuine Leather Soft grip  | Koga Genuine Leather Multigrip  | Koga Genuine Leather Soft grip  |
| Shimano Deore V-rimbrake  | Shimano Deore LX V-rimbrake   | Shimano Deore V-rimbrake  | Shimano Deore LX V-rimbrake   |
| Shimano Deore rapid fire plus - Two way release - Optical gear display  | Shimano Deore LX rapid fire plus - Two way release - Optical gear display   | Shimano Deore rapid fire plus - Two way release - Optical gear display  | Shimano Deore LX rapid fire plus - Two way release - Optical gear display   |
| Shimano Deore   | Shimano Deore LX  | Shimano Deore   | Shimano Deore LX  |
| -   | -   | -   | -   |
| Stainless steel inner cable -Flexible outer cable with teflon tube for light braking  | Stainless steel inner cable -Flexible outer cable with teflon tube for light braking  | Stainless steel inner cable -Flexible outer cable with teflon tube for light braking  | Stainless steel inner cable -Flexible outer cable with teflon tube for light braking  |
| Shimano Deore LX Hyperglide for smooth shifting and riding  | Shimano Deore LX Hyperglide for smooth shifting and riding  | Shimano Deore LX Hyperglide for smooth shifting and riding  | Shimano Deore LX Hyperglide for smooth shifting and riding  |
| -   | -   | -   | -   |
| Shimano DH-3N72 6V/3,0W - Lightweight sporthub - Low rotating friction - Quick Release  | Shimano Deore LX - Double contact sealing for low maintenance and increased service life  | Shimano DH-3N72 6V/3,0W - Lightweight sporthub - Low rotating friction - Quick Release  | Shimano Deore LX - Double contact sealing for low maintenance and increased service life  |
| Shimano Deore - Internal grease sleeve for increased service life   | Shimano Deore LX - Double contact sealing for low maintenance and increased service life  | Shimano Deore - Internal grease sleeve for increased service life   | Shimano Deore LX - Double contact sealing for low maintenance and increased service life  |
| Schwalbe Marathon Racer 35mm - RaceGuard: puncture protection/low rolling resistance - Side reflection  | Vredestein Perfect Girando Sportex 32mm - Sportex Protection Layer® - Side reflection   | Schwalbe Marathon Racer 35mm - RaceGuard: puncture protection/low rolling resistance - Side reflection  | Vredestein Perfect Girando Sportex 32mm - Sportex Protection Layer® - Side reflection   |
| Koga KM19-622 Xlite alloy - Double wall and double eyeletted 36 holes - Durable finished - Black color  | Koga KM19-622 Xlite alloy - Double wall and double eyeletted 36 holes - Durable finished - Black color  | Koga KM19-622 Xlite alloy - Double wall and double eyeletted 36 holes - Durable finished - Black color  | Koga KM19-622 Xlite alloy - Double wall and double eyeletted 36 holes - Durable finished - Black color  |
| Sapim stainless - Cold forged reinforced - Black color  | Sapim stainless - Cold forged reinforced - Black color  | Sapim stainless - Cold forged reinforced - Black color  | Sapim stainless - Cold forged reinforced - Black color  |
| Fi'zi:k Rondine - Wingflex system - Black/Silver/Blue color   | Selle Royal Look In - Superior comfort  | Fi'zi:k Rondine - Wingflex system - Black/Silver/Blue color   | Selle Royal Look In - Superior comfort  |
| Post Moderne alloy - Shock absorbing - Safety Clamp construction - Travel 30mm - Black color  | Post Moderne alloy - Shock absorbing - Safety Clamp construction - Travel 30mm - Black color  | Satori alloy - Safety Clamp construction - Black color  | Satori alloy - Safety Clamp construction - Black color  |
| Koga alloy  | Koga alloy  | Koga alloy  | Koga alloy  |
| Shimano Hollowtech II with Chainguide - Ultralightweight - Hyperdrive chainrings for smooth and precise shifting: 44x32x22T - Black color   | Shimano Hollowtech II - Ultralightweight - Hyperdrive chainrings for smooth and precise shifting: 48x36x26T - Silver color  | Shimano Octalink - Hyperdrive chainrings for smooth and precise shifting: 44x32x22T with Chain-Guide - Black color  | Shimano Hollowtech II - Ultralightweight - Hyperdrive chainrings for smooth and precise shifting: 48x36x26T - Silver color  |
| Koga VP-191 alloy - Industrial bearing - Anti slip layer  | Koga VP-191 alloy - Industrial bearing - Anti slip layer  | Shimano splined and hollow - Lightweight - Maintenance free bearing   | Shimano splined and hollow - Lightweight - Maintenance free bearing   |
| Shimano Tiagra 9 speed - Hyperglide for quick and smooth shifting - Sprockets: 12-13-14-15-17-19-21-23-25T  | Shimano Tiagra 9 speed - Hyperglide for quick and smooth shifting - Sprockets: 12-13-14-15-17-19-21-23-25T  | Koga VP-191 alloy - Industrial bearing - Anti slip layer  | Koga VP-191 alloy - Industrial bearing - Anti slip layer  |
| Shimano Deore LX  | Shimano Deore LX  | Shimano Tiagra 9 speed - Hyperglide for quick and smooth shifting - Sprockets: 12-13-14-15-17-19-21-23-25T  | Shimano Tiagra 9 speed - Hyperglide for quick and smooth shifting - Sprockets: 12-13-14-15-17-19-21-23-25T  |
| Shimano Deore   | Shimano Deore LX  | Shimano Deore LX  | Shimano Deore LX  |
| 27  | 27  | Shimano Deore   | Shimano Deore LX  |
| Koga alloy - Black color  | Koga alloy - Black color  | Koga alloy - Black color  | Koga alloy - Black color  |
| Koga Rookie XL Special - Ergonomic hinge grip   | Koga Rookie XL Special - Ergonomic hinge grip   | Koga Rookie XL High   | Koga Rookie XL High   |
| Witek Compact   | Witek Compact   | Witek Compact   | Witek Compact   |
| -   | Hesling Esencia   | -   | Hesling Esencia   |
| SKS P-45 - Black/Silver color   | SKS P-45 - Black/Silver color   | SKS P-45 - Black/Silver color   | SKS P-45 - Black/Silver color   |
| SKS P-45 - Integrated rear light wiring - Black/Silver color  | SKS P-45 - Black/Silver color   | SKS P-45 - Integrated rear light wiring - Black/Silver color  | SKS P-45 - Black/Silver color   |
| -   | -   | -   | -   |
| Koga Rayo - New IQ-LED technology 32 Lux - Integrated reflector - KBA approved -Black color   | Cateye HLEL135 - Opticube lens technology with wide beam pattern - Batteries included   | Koga Rayo - New IQ-LED technology 32 Lux - Integrated reflector - KBA approved -Black color   | Cateye HLEL135 - Opticube lens technology with wide beam pattern - Batteries included   |
| B&M Toplight Flat plus - Long life LED technology - Lightweight - Standlight function - KBA approved - Black color  | B&M DToplight XS senso - Long life LED technology - Battery included - KBA approved   | B&M Toplight Flat plus - Long life LED technology - Lightweight - Standlight function - KBA approved - Black color  | B&M DToplight XS senso - Long life LED technology - Battery included - KBA approved   |
| Hub   | Hub   | Hub   | -   |
| Hub   | Hub   | Hub   | -   |
| Hub   | Hub   | Hub   | -   |
| Tubus Vega - Steel tubing max 25 kg - Durable black powdercoated finish - 10 years guarantee  | Racktime Lightit - Alloy hollow tubing max 20 kg - Durable black finish   | Tubus Vega - Steel tubing max 25 kg - Durable black powdercoated finish - 10 years guarantee  | Racktime Lightit - Alloy hollow tubing max 20 kg - Durable black finish   |
| Atran Stylo Adjustable - Superb stability - Powdercoated durable finish - Black color   | Atran Stylo Adjustable - Superb stability - Powdercoated durable finish - Black color   | Atran Stylo Adjustable - Superb stability - Powdercoated durable finish - Black color   | Atran Stylo Adjustable - Superb stability - Powdercoated durable finish - Black color   |
| Selle Royal with ICS click system   | Selle Royal with ICS click system   | Selle Royal with ICS click system   | Selle Royal with ICS click system   |





|                                  | Alliance NEWCOMFORT (G/L/LE)  | Prominence (G/L)   | Confidence (G/L)   | Balance (G/L)  |
|----------------------------------|---|--|--|--|
| <b>Frame sizes</b>               | G: 50-54-57-60-63cm<br>L: 47-50-53-56-59cm<br>LE: 47-50-53-56cm   | G: 50-54-57-60-63-66cm<br>L: 47-50-53-56-59cm  | G: 50-54-57-60-63cm<br>L: 47-50-53-56-59cm   | G: 50-54-57-60-63cm<br>L: 47-50-53-56cm  |
| <b>Weight</b>                    | 17,5 Kg   | 16,4 Kg  | 18,3 Kg  | 18,5 Kg  |
| <b>Price</b>                     | € 1.699,0   | € 1.699,0  | € 1.399,0  | € 1.299,0  |
| <b>Colour</b>                    | Warm light grey/Pearl midnight blue   | Solid black/High polish  | Quartz grey metallic/Solid black   | Azure blue metallic/Pearl silver   |
| <b>Frame description</b>         | Completely hand-built Super Smooth TiG-welded frame. Tubes manufactured in triple-hardened and triple-buttet 7005 aluminium. Down tube with integrated shifter cable. Equipped with integrated headset and basements for all accessories and a replaceable rear derailleur hanger. (L) low step-through frame; (LE) Low entry frame). | Completely hand-built Super Smooth TiG-welded Semi Twin Tube frame. Tubes manufactured in triple-hardened 7005 aluminium. Equipped with integrated headset, rear carrier and basements for all accessories and a replaceable rear derailleur hanger. (L) low step through frame. | Completely hand-built Super Smooth TiG-welded frame. Tubes manufactured in triple-hardened and triple butted 7005 aluminium. Down tube with integrated shifter and brake cables. Equipped with integrated headset and basements for all accessories. (L) low step through frame. | Completely hand-built Super Smooth TiG-welded frame. Tubes manufactured in triple-hardened and triple butted 7005 aluminium. Down tube with integrated shifter and brake cables. Equipped with integrated headset and basements for all accessories. (L) low step through frame. |
| <b>Front fork</b>                | Koga Feather - Lightweight - Ball bearing guided suspension fork - Travel 35 mm   | Koga Feather - Lightweight - Ball bearing guided suspension fork - Travel 35 mm  | SR Suntour SF9-CR8V - Light alloy - Travel 50mm - Lock-out   | SR Suntour SF9-CR8V - Light alloy - Travel 50mm - Lock-out   |
| <b>Headset</b>                   | Tange Seiki ball bearing -Integrated in frame   | Tange Seiki ball bearing -Integrated in frame  | Tange Seiki ball bearing -Integrated in frame  | Tange Seiki ball bearing -Integrated in frame  |
| <b>BrakePowerControl</b>         | Yes   | Yes  | Yes  | Yes  |
| <b>Handlebar</b>                 | Koga ComFormer Controlbar - Adjustable - Silver color   | Koga Touring alloy - Lightweight - Silver color  | Koga Multigrip - Ergonomic multiposition handlebar - Black color   | Koga Touring alloy - Lightweight - Silver color  |
| <b>Stem</b>                      | Koga adjustable stem - A-head - Silver color  | Koga adjustable stem - A-head - Silver color   | Koga adjustable stem - quill ø25,4 - Black color   | Koga alloy Easystem - Toolless adjustable - quill ø25,4 - Silver color   |
| <b>Grips</b>                     | Koga Ergonomic genuine leather  | Koga Ergonomic genuine leather with brown stitching  | Koga Genuine Leather Multigrip   | Koga Ergonomic genuine leather   |
| <b>Brake (front)</b>             | -   | Shimano Deore LX V-rimbrake  | -  | Shimano V-rimbrake   |
| <b>Brake (rear)</b>              | -   | Shimano Deore LX V-rimbrake  | -  | Shimano V-rimbrake   |
| <b>Shift-/Brake lever</b>        | -   | -  | -  | -  |
| <b>Shift lever</b>               | SRAM Dual Drive 27-speed shifter with click box   | Shimano Deore LX - Rapid fire plus and two way release shifting with optical gear display  | Shimano Deore rapid fire plus with optical gear display  | Shimano Deore rapid fire plus with optical gear display  |
| <b>Brake lever</b>               | -   | -  | -  | Shimano  |
| <b>Disc-/Hydraulic brake set</b> | Magura HS-11 Hydraulic rimbrake - Excellent braking power maintenance free  | -  | Magura HS-11 Hydraulic rimbrake - Excellent braking power maintenance free   | -  |
| <b>Cables</b>                    | -   | Stainless steel inner cable -Flexible outer cable with teflon tube for light braking   | Stainless steel inner cable -Flexible outer cable with teflon tube for light braking   | Stainless steel inner cable -Flexible outer cable with teflon tube for light braking   |
| <b>Chain</b>                     | Shimano Deore LX Hyperglide for smooth shifting and riding  | Shimano Deore LX Hyperglide for smooth shifting and riding   | Shimano Deore Hyperglide for smooth shifting and riding  | Shimano Hyperglide for smooth shifting and riding  |
| <b>Front hub</b>                 | Shimano DH-3N72 6V/3,0W - Lightweight sporthub - Low rotating friction - Quick Release  | Shimano DH-3N72 6V/3,0W - Lightweight sporthub - Low rotating friction - Quick Release   | Shimano DH-3N30 6V/3,0W - Low rotating friction - Quick Release  | Shimano DH-3N30 6V/3,0W - Low rotating friction - Quick Release  |
| <b>Rear hub</b>                  | SRAM Dual Drive - IGH freewheel for quick and smooth shifting - Silver anodized finish  | Shimano Deore LX - Double contact sealing for low maintenance and increased service life   | Shimano Deore - Internal grease sleeve for increased service life  | Shimano Deore - Internal grease sleeve for increased service life  |
| <b>Tires</b>                     | Schwalbe Energizer 37 mm - Kevlar Protection - Side reflection  | Schwalbe marathon Supreme 37 mm - HD-Guard: Vectran puncture protection - Magic Compound: low rolling resistance + Supreme grip - Side reflection  | Schwalbe Delta Cruiser 37mm - Puncture Protection - Side reflection  | Schwalbe City Lite 37mm - Puncture Protection - Side reflection  |
| <b>Rims</b>                      | Koga KM19-622 alloy - Double wall and double eyeletted 36 holes - Durable finished - Black color  | Koga KM19-622 alloy - Double wall and double eyeletted 36 holes - Durable finished - Silver color  | Koga KM19-622 alloy - Double wall and double eyeletted 36 holes - Durable finished - Black color   | Koga KM19-622 alloy - Double wall and double eyeletted 36 holes - Durable finished - Silver color  |
| <b>Spokes</b>                    | Sapim stainless - Cold forged reinforced - Black color  | Sapim stainless - Cold forged reinforced   | Sapim stainless - Cold forged reinforced   | Sapim stainless - Cold forged reinforced   |
| <b>Saddle</b>                    | Selle Royal Respiro Relaxed Lady - Air ventilation - Reduced heat adsorption  | Selle Royal Look IN M Flex - Superior comfort for alcantara inserts  | Selle Royal Wave - Royal Gel inside - Scuff guards - Koga logo   | Selle Royal Wave - Royal Gel inside - Scuff guards - Koga logo   |
| <b>Seat post</b>                 | Post Moderne alloy - Shock absorbing - Safety Clamp construction - Travel 30mm - Silver color   | Post Moderne alloy - Shock absorbing - Safety Clamp construction - Travel 30mm - Silver color  | Post Moderne alloy - Shock absorbing - Safety Clamp construction - Travel 30mm - Black color   | Satori alloy - Shock absorbing - Safety Clamp construction - Travel 30mm - Silver color  |
| <b>Seat clamp</b>                | Koga alloy  | Koga alloy   | Koga alloy   | Koga alloy   |
| <b>Crank set</b>                 | Truvativ FiveD Dual Drive - Pitch black color   | Shimano Deore LX Hollowtech II - Lightweight - Hyperdrive chainrings for smooth and precise shifting: 44x32x22T - Silver color   | Shimano Octalink - Hyperdrive chainrings for smooth and precise shifting: 44x32x22T - Black color  | Shimano 42x32x22T - Silver color   |
| <b>Bottom bracket</b>            | Truvativ Powerspline - Sealed cartridge bearing   | -  | Shimano splined and hollow - Lightweight - Maintenance free bearing  | Sealed cartridge   |
| <b>Pedals</b>                    | Koga VP-191 alloy - Industrial bearing - Anti slip layer  | Koga VP-191 alloy - Industrial bearing - Anti slip layer   | Koga VP-191 alloy - Industrial bearing - Anti slip layer   | Koga VP-191 alloy - Industrial bearing - Anti slip layer   |
| <b>Cassette</b>                  | SRAM PG-970 9speed - PowerGlide technology 11-12-14-16-18-21-24-28-32T  | Shimano HG-80 Deore LX 9 speed - Hyperglide for quick and smooth shifting - Sprockets: 11-12-14-16-18-21-24-28-32T   | Shimano Deore 9 speed - Hyperglide for quick and smooth shifting - Sprockets: 11-12-14-16-18-21-24-28-32T  | Shimano 9 speed - Hyperglide for quick and smooth shifting - Sprockets: 11-13-15-18-21-24-28-32T   |
| <b>Rear derailleur</b>           | SRAM Dual Drive   | Shimano Deore LX   | Shimano Deore  | Shimano Deore  |
| <b>Front derailleur</b>          | -   | Shimano deore LX   | Shimano Deore  | Shimano  |
| <b>Gears</b>                     | 27  | 27   | 27   | 24   |
| <b>Derailleur guard</b>          | -   | Koga stainless steel   | Koga stainless steel   | Koga stainless steel   |
| <b>Pump</b>                      | Koga Rookie XL Special - Ergonomic hinge grip   | Koga Rookie XL Special - Ergonomic hinge grip  | Koga Rookie XL High  | Koga Rookie XL Tec   |
| <b>Bell</b>                      | Widek Compact   | Widek Compact  | Widek Compact  | Widek Compact  |
| <b>Chain guard</b>               | De Woerd Flex guard   | De Woerd Flex guard  | De Woerd Flex guard  | De Woerd Flex guard  |
| <b>Mudguard (f)</b>              | SKS P-45 - Black/Silver color   | SKS P-45 - Black/Silver color  | SKS P-45 - Black/Silver color  | SKS P-45 - Black/Silver color  |
| <b>Mudguard (r)</b>              | SKS P-45 - Integrated rear light wiring - Black/Silver color  | SKS P-45 - Integrated rear light wiring - Black/Silver color   | SKS P-45 - Integrated rear light wiring - Black/Silver color   | SKS P-45 - Integrated rear light wiring - Black/Silver color   |
| <b>Coat guards</b>               | Koga Monocle - Black color  | Koga compact lightweight coatguards  | Koga Monocle - Black color   | Koga Monocle - Black color   |
| <b>Headlight</b>                 | Koga Rayo Senso+ - New IQ-LED technology 32 Lux - Standlight function - Integrated reflector - KBA approved -Black color  | Koga Rayo Senso+ - New IQ-LED technology 32 Lux - Standlight function - Integrated reflector - KBA approved -Black color   | Koga Rayo Senso - New IQ-LED technology 32 Lux - Integrated reflector - KBA approved -Black color  | Koga Rayo Senso - New IQ-LED technology 32 Lux - Integrated reflector - KBA approved -Black color  |
| <b>Rear light</b>                | Busch&Müller Koga Luminance - Multi-angle Long life 5*LED technique - KBA approved - Black color  | Busch&Müller Koga Luminance - Multi-angle Long life 5*LED technique - KBA approved - Black color   | Busch&Müller Koga Luminance - Multi-angle Long life 5*LED technique - KBA approved - Black color   | Busch&Müller Koga Luminance - Multi-angle Long life 5*LED technique - KBA approved - Black color   |
| <b>Dynamo</b>                    | Hub   | Hub  | Hub  | Hub  |
| <b>Rear carrier</b>              | Koga Racktime -Alloy hollow tubing max 30 kg - Integrated Snapit mounting points for accessories -Durable black finish  | Racktime frame integrated - Black durable finish   | Koga Racktime -Alloy hollow tubing max 30 kg - Integrated Snapit mounting points for accessories -Durable black finish   | Koga Racktime -Alloy hollow tubing max 30 kg - Integrated Snapit mounting points for accessories -Durable black finish   |
| <b>Rubber strap</b>              | Widek Triobinder T - Black color  | Widek Triobinder T - Black color   | Widek Triobinder T - Black color   | Widek Triobinder T - Black color   |
| <b>Kickstand</b>                 | Pletscher Optima - Superb stability - Powdercoated durable finish - Black color   | Pletscher Optima - Superb stability - Powdercoated durable finish - Black color  | Pletscher Optima - Superb stability - Powdercoated durable finish - Black color  | Pletscher Optima - Superb stability - Powdercoated durable finish - Black color  |
| <b>Ring lock</b>                 | AXA Defender RL - ART ** approved - Folding key - Black color   | AXA Defender RL - ART ** approved - Folding key - Black color  | AXA Defender RL - ART ** approved - Folding key - Black color  | AXA Defender RL - ART ** approved - Folding key - Black color  |
| <b>Saddlebag</b>                 | Koga Medium with ICS click system   | Koga Medium with ICS click system  | Koga Medium with ICS click system  | Koga Medium with ICS click system  |



| SilverAce (G/L)   | CityLite (G/L)   | Tesla-S (G/L)  | Tesla (G/L)  | Tesla RE (G/L)   |
|---|--|--|--|--|
| G: 50-54-57-60-63cm<br>L: 47-50-53-56-59cm  | G: 50-54-57-60-63cm<br>L: 47-50-53-56cm  | G: 54-57-60cm<br>L: 47-50-53-56cm  | G: 54-57-60cm<br>L: 47-50-53-56cm  | G: 54-57-60cm<br>L: 47-50-53-56cm  |
| 19,7 Kg<br>€ 1.299,0  | 14,6 Kg<br>€ 1.199,0   | 28,5 Kg<br>€ 3.099,0   | 28,5 Kg<br>€ 2.799,0   | 28,5 Kg<br>€ 2.899,0   |
| Blue grey metallic/Solid black OR<br>Bordeaux red metallic/Pearl silver   | Sapphire blue metallic/High polish   | Bordeaux red metallic/Winning silver   | Warm light grey/Pearl midnight blue//<br>OR Winning Silver/Maine grey metallic/<br>Nano black  | NanoBlack  |
| Completely hand-built Super Smooth<br>TiG-welded frame. Tubes manufactured<br>in triple-hardened and triple butted<br>7005 aluminium. Down tube with<br>integrated shifter and brake cables.<br>Equipped with integrated headset and<br>basements for all accessories and an<br>eccentric chain adjuster. (L) low step<br>through frame.<br>SR Soutour SF7-CR8R - Light alloy -<br>Travel 40mm - Lock-out<br>Tange Seiki ball bearing -Integrated<br>in frame<br>-<br>Koga Touring alloy - Lightweight - Silver<br>color<br>Koga alloy Easystem - Toolless adjust-<br>able - quill ø25,4 - Silver color<br>Koga Ergonomic genuine leather | Completely hand-built Super Smooth<br>TiG-welded frame. Tubes manufactured<br>in triple-hardened and triple butted<br>7005 aluminium. Down tube with<br>integrated shifter cable. Equipped with<br>integrated headset and basements for<br>all accessories and an eccentric chain<br>adjuster. (L) low step through frame.<br>Chromo-Alloy<br>Tange Seiki ball bearing -Integrated<br>in frame<br>-<br>ITM The Bird alloy - Lightweight - Black<br>color<br>ITM Trekking alloy - adjustable - quill<br>ø25,4 - Black color<br>Koga Ergonomic genuine leather | Completely hand-built Super Smooth<br>TiG-welded frame. Tubes manufactured<br>in triple-hardened 7005 aluminium.<br>Special "diamond shape" down tube<br>with internal battery pack. Equipped<br>with integrated new designed headset<br>and basements for all accessories.(L)<br>low step through frame.<br>SR Soutour SF9-CR-9V D Ultra light<br>Magnesium - Travel 63mm - Lock-out<br>Tange Seiki ball bearing -Integrated<br>in frame<br>-<br>Koga Multigrip - Ergonomic multiposi-<br>tion handlebar - Silver color<br>Pro alloy - adjustable - quill ø25,4 -<br>Silver color<br>Koga Genuine Leather Multigrip | Completely hand-built Super Smooth<br>TiG-welded frame. Tubes manufactured<br>in triple-hardened 7005 aluminium.<br>Special "diamond shape" down tube<br>with internal battery pack. Equipped<br>with integrated new designed headset<br>and basements for all accessories.<br>SR Soutour SF7-CR8R - Light alloy -<br>Travel 40mm - Lock-out<br>Tange Seiki ball bearing -Integrated<br>in frame<br>-<br>Koga Touring alloy - Lightweight - Silver<br>color<br>Koga alloy Easystem - Toolless adjust-<br>able - quill ø25,4 - Silver color<br>Koga Ergonomic genuine leather | Completely hand-built Super Smooth<br>TiG-welded frame. Tubes manufactured<br>in triple-hardened and double butted<br>7005 aluminium. Equipped with<br>integrated headset and basements for<br>all accessories.(L) with low step through<br>frame.<br>Koga Feather - Lightweight - Ball bearing<br>guided suspension fork - Travel 35 mm<br>Tange Seiki ball bearing -Integrated<br>in frame<br>-<br>Koga Touring alloy - Lightweight - Silver<br>color<br>Koga adjustable stem - A-head - Silver<br>color<br>Koga Ergonomic genuine leather |
| Shimano Rollerbrake<br>Shimano Rollerbrake<br>Shimano Nexus Tap fire with optical<br>gear display<br>-<br>Shimano Nexus<br>-<br>Stainless steel inner cable -Flexible<br>outer cable with teflon tube for light<br>braking<br>KMC Z6 10HX for smooth shifting and<br>riding<br>Shimano DH-3R30 6V/3,0W - Low<br>rotating friction - Quick Release   | Shimano V-rimbrake<br>Shimano V-rimbrake<br>Shimano Nexus Tap fire with optical<br>gear display<br>-<br>Shimano Nexus<br>-<br>Stainless steel inner cable -Flexible<br>outer cable with teflon tube for light<br>braking<br>KMC Z6 10HX for smooth shifting and<br>riding<br>Shimano Deore LX - Internal grease<br>sleeve for increased service life   | -<br>-<br>-<br>Shimano Revo with optical gear<br>display<br>-<br>Magura HS-33 Hydraulic rimbrake -<br>Excellent braking power maintenance<br>free<br>Shimano HG-70 Hyperglide for smooth<br>shifting and riding<br>Shimano Nexave - Quick release<br>Koga Electronic<br>Schwalbe Energizer 37 mm - Kevlar<br>Protection - Side reflection  | Shimano Rollerbrake<br>Drum brake<br>Shimano Nexave T300 with optical<br>gear display<br>-<br>-<br>-<br>Stainless steel inner cable -Flexible<br>outer cable with teflon tube for light<br>braking<br>Shimano HG-70 Hyperglide for smooth<br>shifting and riding<br>Shimano Nexave<br>Koga Electronic<br>Schwalbe Energizer 37 mm - Kevlar<br>Protection - Side reflection   | Shimano V-rimbrake<br>Shimano V-rimbrake<br>Shimano Revo with optical gear<br>display<br>-<br>Shimano<br>-<br>Stainless steel inner cable -Flexible<br>outer cable with teflon tube for light<br>braking<br>Shimano HG-70 Hyperglide for smooth<br>shifting and riding<br>Shimano DH-3N72 6V/3,0W - Light-<br>weight sporthub - Low rotating friction<br>- Quick Release<br>Koga Electronic<br>Schwalbe Energizer 37 mm - Kevlar<br>Protection - Side reflection   |
| Shimano Nexus-8 Premium - 8 internal<br>gears in hub - Premium: High driving<br>efficiency and increased service life<br>Koga COM4T 37mm - Kevlar protec-<br>tion - Side reflection   | Shimano Nexus-8 Premium - 8 internal<br>gears in hub - Premium: High driving<br>efficiency and increased service life<br>Schwalbe Marathon Racer 35mm -<br>RaceGuard: puncture protection/low<br>rolling resistance - Side reflection  | Koga Electronic  | Koga Electronic  | Koga Electronic  |
| Koga KM19-622 alloy - Double wall<br>and double eyeletted 36 holes - Dura-<br>ble finished - Silver color<br>Sapim stainless - Cold forged<br>reinforced<br>Selle Royal Wave - Royal Gel inside -<br>Suff guards - Koga logo<br>Satori alloy - Shock absorbing - Safety<br>Clamp construction - Travel 30mm -<br>Silver color<br>Koga alloy<br>Shimano Nexus 38T - Smooth surface<br>- Silver color   | Koga KM19-622 alloy - Double wall<br>and double eyeletted 36 holes - Dura-<br>ble finished - Black color<br>Sapim stainless - Cold forged<br>reinforced<br>Selle Royal Look IN M Flex -Superior<br>comfort<br>Satori alloy - Safety Clamp construction<br>- Black color<br>Koga alloy<br>Shimano Nexus 38T - Smooth surface<br>- Silver color  | Rigida Stratos/Andra 19-622 alloy -<br>Double wall and double eyeletted 36<br>holes - Durable finished - Silver color<br>Sapim stainless - Cold forged reinforc-<br>ed - Butted<br>Selle Royal Look IN M Flex -Superior<br>comfort with alcantara inserts<br>Post Moderne alloy - Shock absorbing<br>- Safety Clamp construction - Travel<br>30mm - Silver color<br>Koga alloy<br>Shimano Octalink - Hyperdrive chain-<br>ings for smooth and precise shifting:<br>42x32x22T - Silver color  | Rigida Stratos/Andra 19-622 alloy -<br>Double wall and double eyeletted 36<br>holes - Durable finished - Silver color<br>Sapim stainless - Cold forged reinforc-<br>ed - Butted<br>Selle Royal Look IN M Flex -Superior<br>comfort with alcantara inserts<br>Post Moderne alloy - Shock absorbing<br>- Safety Clamp construction - Travel<br>30mm - Silver color<br>Koga alloy<br>Shimano Octalink - Hyperdrive chain-<br>ings for smooth and precise shifting:<br>42x32x22T - Silver color  | Rigida Stratos/Andra 19-622 alloy -<br>Double wall and double eyeletted 36<br>holes - Durable finished - Silver color<br>Sapim stainless - Cold forged reinforc-<br>ed - Butted<br>Selle Royal Look IN M Flex -Superior<br>comfort with alcantara inserts<br>Post Moderne alloy - Shock absorbing<br>- Safety Clamp construction - Travel<br>30mm - Silver color<br>Koga alloy<br>Shimano Octalink - Hyperdrive chain-<br>ings for smooth and precise shifting:<br>42x32x22T - Silver color  |
| Sealed cartridge  | Sealed cartridge   | Shimano splined and hollow - Light-<br>weight - Maintenance free bearing<br>Koga VP-191 alloy - Industrial bearing<br>- Anti slip layer<br>Shimano - Hyperglide for quick and<br>smooth shifting - Sprockets:<br>13-15-17-19-21-24-28T   | Shimano splined and hollow - Light-<br>weight - Maintenance free bearing<br>Koga VP-191 alloy - Industrial bearing<br>- Anti slip layer<br>Shimano - Hyperglide for quick and<br>smooth shifting - Sprockets:<br>13-15-17-19-21-24-28T   | Shimano splined and hollow - Light-<br>weight - Maintenance free bearing<br>Koga VP-191 alloy - Industrial bearing<br>- Anti slip layer<br>Shimano - Hyperglide for quick and<br>smooth shifting - Sprockets:<br>13-15-17-19-21-24-28T   |
| -<br>-<br>8<br>-<br>Koga Rookie XL Tec  | -<br>-<br>8<br>-<br>Koga Rookie XL Tec   | Shimano Deore LX<br>Shimano Alivio<br>21<br>Koga alloy - Black color<br>Koga Rookie XL Special - Ergonomic<br>hinge grip<br>Widek Compact<br>De Woerd Flex guard<br>SKS P-45 -Titan color<br>SKS P-45 - Integrated rear light wiring<br>- Titan color<br>Koga Monocle - Titan color<br>B&M DLumotec topal senso - Long life<br>LED technology - KBA approved - Titan<br>color  | Shimano Deore<br>Shimano Alivio<br>21<br>Koga alloy - Black color<br>Koga Rookie XL Special - Ergonomic<br>hinge grip<br>Widek Compact<br>De Woerd Flex guard<br>SKS P-45 -Titan color<br>SKS P-45 - Integrated rear light wiring<br>- Titan color<br>Koga Monocle - Titan color<br>Koga Rayo - New IQ-LED technology<br>32 Lux - Integrated reflector - KBA<br>approved - Titan color   | Shimano Deore<br>Shimano Alivio<br>21<br>Koga alloy - Black color<br>Koga Rookie XL Special - Ergonomic<br>hinge grip<br>Widek Compact<br>De Woerd Flex guard<br>SKS P-45 - Black/Silver color<br>SKS P-45 - Integrated rear light wiring -<br>Black/Silver color<br>Koga Monocle - Black color<br>Koga Rayo Senso - New IQ-LED<br>technology 32 Lux - Integrated reflector<br>- Standlight function - KBA approved<br>-Black color  |
| Busch&Müller Koga Luminance - Multi-<br>angle Long life 5*LED technique - KBA<br>approved - Black color<br>Hub<br>Koga Racktime -Alloy hollow tubing<br>max 30 kg - Integrated Snapit moun-<br>ting points for accessories -Durable<br>black finish<br>Widek Triobinder T - Black color<br>Pletscher Optima - Superb stability -<br>Powdercoated durable finish - Black<br>color<br>AXA Defender RL - ART ** approved -<br>Folding key - Black color<br>Koga Medium with ICS click system   | B&M DToplight XS senso - Long life LED<br>technology - Battery included - KBA<br>approved<br>Racktime Lightit - Alloy hollow tubing<br>max 20 kg - Durable black finish<br>Widek Triobinder T - Black color<br>Atran Stylo Adjustable - Superb stability<br>- Powdercoated durable finish - Black<br>color<br>-<br>Koga Medium with ICS click system   | Busch&Müller Koga Luminance - Multi-<br>angle Long life 5*LED technique - KBA<br>approved - Titan color<br>-<br>Koga Racktime -Alloy hollow tubing<br>max 30 kg - Durable titan finish<br>Widek Triobinder T - Black color<br>Pletscher Optima - Superb stability -<br>Powdercoated durable finish - Titan<br>color<br>Trellock RS 440 - ART ** approved - Anti<br>theft chip - Folding key - Black color<br>Koga Medium with ICS click system   | Busch&Müller Koga Luminance - Multi-<br>angle Long life 5*LED technique - KBA<br>approved - Titan color<br>-<br>Koga Racktime -Alloy hollow tubing<br>max 30 kg - Durable titan finish<br>Widek Triobinder T - Blue color<br>Pletscher Optima - Superb stability -<br>Powdercoated durable finish - Titan<br>color<br>Trellock RS 440 - ART ** approved - Anti<br>theft chip - Folding key - Black color<br>Koga Medium with ICS click system  | Busch&Müller Koga Luminance - Multi-<br>angle Long life 5*LED technique - KBA<br>approved - Black color<br>-<br>Koga Racktime -Alloy hollow tubing<br>max 30 kg - Durable black finish<br>Widek Triobinder T - Black color<br>Pletscher Optima - Superb stability -<br>Powdercoated durable finish - Black<br>color<br>Trellock RS 440 - ART ** approved - Anti<br>theft chip - Folding key - Black color<br>Koga Medium with ICS click system   |



|                                  | Twintraveller(susp)  | Vector  | Founder-S   |
|----------------------------------|--|---|---|
| <b>Frame sizes</b>               | Front: 54cm Rear: 50cm   | 50-54-57-60cm   | Uni size  |
| <b>Weight</b>                    | 29,2 Kg  | 15,9 Kg   | 14,3 Kg   |
| <b>Price</b>                     | € 3.999,0  | € 1.499,0   | € 1.499,0   |
| <b>Colour</b>                    | Aluminium paint/Grey polish  | Starry Night  | NanoBlack/Chrome Red/High polish  |
| <b>Frame description</b>         | Completely hand-built Super Smooth TIG-welded full suspension Y-tech tandem folding frame. Tubes manufactured in triple-hardened and super oversized 7005 aluminium for extra stability. Equipped with basements for all accessories. Rear swing arm with adjustable oil/spring suspension unit (80mm travel) and extra disc brake and a replaceable rear derailleur hanger. | Hand-built Super Smooth TIG-welded 26" frame. Tubes manufactured in triple-hardened and triple-buttet 7005 aluminium. Top- and down tube oval and oversized in combination with robust monostay for extra stability. Equipped with integrated headset, basements for all accessories, integrated kickstand and integrated rear-light attachment directly on frame. Finished with a durable Starry Night powdercoating | Completely hand-built Super Smooth TIG-welded full suspension folding frame. Tubes manufactured in triple-hardened 7005 aluminium. Equipped with integrated rear carrier. Rear swing arm with adjustable air shock suspension unit with rebound control (20mm travel) and a replaceable rear derailleur hanger. |
| <b>Front fork</b>                | Fastrax double bridge  |   | Fastrax dual link   |
| <b>Shock</b>                     | Fastrax air ARL - Rebound adjustment   |   | Fastrax Air   |
| <b>Headset</b>                   | VP industrial bearing  | Tange Seiki ball bearing -Integrated in frame   | VP ball bearing   |
| <b>BrakePowerControl</b>         | -  |   | Yes   |
| <b>Handlebar</b>                 | Front: Koga Multigrip - Ergonomic multiposition handlebar - Black color<br>Rear:Pro double butted alloy - Sand Blasted Black color   | Ritchey Comp mountain straight alloy - Black color  | ITM Moustache alloy - Silver color  |
| <b>Stem</b>                      | Front: Koga alloy - adjustable - A-head - Sand Blasted Black color<br>Rear: - Koga alloy - Black color   | Koga adjustable stem - A-head - Black color   | Koga telescopic - Easy adjustable - Silver color  |
| <b>Grips</b>                     | Koga Genuine Leather Multigrip & Koga Genuine Leather Soft grip  | Ergon with integrated bar ends for turn shifter   | Koga Genuine Leather Soft grip  |
| <b>Bar ends</b>                  | Pro BE L-Bend alloy - Black color  |   | -   |
| <b>Brake (front)</b>             | -  |   | Shimano Capreo  |
| <b>Brake (rear)</b>              | Shimano disc brake controlled by Sram X.9 twist shifter - Extra rear brake for descending  |   | Shimano Capreo  |
| <b>Shift-/Brake lever</b>        | -  |   | -   |
| <b>Shift lever</b>               | SRAM X.9 twist shifter with micro index and optical gear display   | Shimano Nexus revo  | Shimano Capreo tap fire with optical gear display   |
| <b>Brake lever</b>               | -  |   | Shimano Capreo  |
| <b>Disc-/Hydraulic brake set</b> | Magura HS-33 Hydraulic rimbrake - Excellent braking power maintenance free   | Magura HS-11 Hydraulic rimbrake - Excellent braking power maintenance free - Firmtech version   | -   |
| <b>Cables</b>                    |  |   | Stainless steel inner cable -Flexible outer cable with teflon tube for light braking  |
| <b>Chain</b>                     | Shimano Deore LX Hyperglide for smooth shifting and riding   | Shimano Hyperglide for smooth shifting and riding   | Shimano Deore LX Hyperglide for smooth shifting and riding  |
| <b>Front hub</b>                 | SON 28 - Low rotating friction - Quick release - Black color   | Shimano DH-3N30 6V/3,0W - Low rotating friction - Quick Release   | Shimano Capreo  |
| <b>Rear hub</b>                  | DT Hügi 540 - 48 holes - Quick Release - Black color   | Shimano Nexus-8 Premium - 8 internal gears in hub - Premium: High driving efficiency and increased service life   | Shimano Capreo  |
| <b>Tires</b>                     | Continental TravelContact 42mm - Kevlar protection - Duraskin side protection - Side reflection  | Schwalbe Big Apple 51 mm - Kevlar Guard - Side reflection   | Schwalbe Marathon Plus 35mm - Smart Guard: Extreme puncture protection - Side reflection  |
| <b>Rims</b>                      | Koga KM21-622 alloy - Double wall and double eyeletted 48 holes - Durable finished - Black color   | Koga KM19-559 alloy - Double wall and double eyeletted 36 holes - Durable finished - Black color  | Rigida Explorer 19-406 alloy - Double wall 24 holes - Durable finished - Silver color   |
| <b>Spokes</b>                    | Sapim stainless - Cold forged reinforced and butted  | Sapim stainless - Cold forged reinforced  | Sapim stainless - Cold forged reinforced  |
| <b>Saddle</b>                    | Selle Italia FLX Man - Genuine full grain leather  | Selle Royal Freccia - Koga logo   | Selle Italia FLX Lady - Genuine full grain leather  |
| <b>Seat post</b>                 | Satori alloy - Safety Clamp construction - Black color   | Satori alloy - Safety Clamp construction - Black color  | Koga telescopic - Easy adjustable - Silver color  |
| <b>Seat clamp</b>                | Koga alloy   | Koga alloy  | Koga alloy  |
| <b>Crank set</b>                 | Shimano Octalink & Hollowtech - Lightweight - Hyperdrive chainrings for smooth and precise shifting: 48x36x26T with chainguard and 32t 2x with chainguard - Black color  | Truativ ISOflow - Pitch black color   | Shimano Capreo 45T with double chainguide   |
| <b>Bottom bracket</b>            | Shimano Deore splined and hollow - Lightweight - Maintenance free bearing  | Truativ Powerspline - Sealed cartridge bearing  | Shimano cartridge   |
| <b>Pedals</b>                    | Multipurpose pedal: SPD side and platform side   | Koga VP-191 alloy - Industrial bearing - Anti slip layer  | Koga VP-113 Folding - Anti slip layer   |
| <b>Cassette</b>                  | Shimano HG-80 Deore LX - Hyperglide for quick and smooth shifting -Sprockets: 11-12-14-16-18-21-24-28-32T  | Shimano Nexus 19T   | Shimano - Hyperglide for quick and smooth shifting - Sprockets: 9-10-11-13-15-17-20-23-26T  |
| <b>Rear derailleur</b>           | SRAM X.9 long cage   |   | Shimano Capreo  |
| <b>Front derailleur</b>          | SRAM X.9   |   | -   |
| <b>Gears</b>                     | 27   | 8   | 9   |
| <b>Derailleur guard</b>          | Koga stainless steel   |   | Koga stainless steel  |
| <b>Pump</b>                      | Topeak Roadmorph Small - Frame mounted floor pump - Ergonomic hinge grip   | Koga Telescopic with alloy barrel - Schrader and Presta fit - High Pressure/Big Volume switch - Ergonomic hinge grip  | Koga Telescopic with alloy barrel - Schrader and Presta fit - High Pressure/Big Volume switch - Ergonomic hinge grip  |
| <b>Bottle holder</b>             | Koga alloy 3x - Hygienic innerlayer - Easy refill - Silver color   |   | -   |
| <b>Bottle</b>                    | Elite Taki 3x  |   | -   |
| <b>Bell</b>                      | Widek Compact  | Widek Decibel II with compass - Black color   | Widek Compact   |
| <b>Chain guard</b>               | -  | Hebie Chainglider - Complete lightweight chain protection   | -   |
| <b>Mudguard (f)</b>              | SKS P-50 - Black/Silver color  | SKS P-55 - Black color  | SKS P-45 - Silver color   |
| <b>Mudguard (r)</b>              | SKS P-50 - Black/Silver color  | SKS P-55 - Black color  | SKS P-45 - Silver color   |
| <b>Coat guards</b>               | -  |   |   |
| <b>Headlight</b>                 | B&M D-Lumotec topal senso - Long life LED technology - KBA approved - Black color  | Basta Pilot Black Edition - Long life Power LED technology - Standlight, automatic, reflector   | Cateye HLEL135 - Opticube lens technology with wide beam pattern - Batteries included   |
| <b>Rear light</b>                | B&M 4DToplight multi senso - Long life LED technology - Battery and Dynamo mode - KBA approved - Black color   | B&M Seculite Plus - Long life LED technology - Lightweight - Standlight function - KBA approved - Black color   | B&M IX-RED - Long life LED technology - Lightweight - KBA approved - Batteries included - Black color   |
| <b>Dynamo</b>                    | Hub  | Hub   | -   |
| <b>Rear carrier</b>              | Tubus Logo - Steel tubing max 40 kg - High/Low bag position - Durable black powdercoated finish - 10 years guarantee   | Koga Stabilow - Steel tubing max 15 kg - Durable black finish   | -   |
| <b>Low-rider</b>                 | Tubus Ergo - Steel tubing max 15 kg - Durable black powdercoated finish - 10 years guarantee   | -   | -   |
| <b>Low-rider kickstand</b>       | Koga - Stability under wind or weight load - Black color   | -   | -   |
| <b>Rubber strap</b>              | Widek Triobinder T - Black color   | -   | -   |
| <b>Kickstand</b>                 | Pletscher Optima and Pletscher Double folding - Superb stability - Powdercoated durable finish - Titan color   | Atran Stylo Adjustable - Superb stability - Powdercoated durable finish - Black color   | Pletscher Double Leg - Superb stability also when folded - Powdercoated durable finish - Black color  |
| <b>Ring lock</b>                 | AXA Defender RL - ART ** approved - Folding key - Black color  | -   | -   |
| <b>Saddlebag</b>                 | Koga Medium with click fix system & Agu Ventura  | Agu Waterproved Klickfix for Koga Stabilow carrier  | Agu Triangle Stretch bag  |



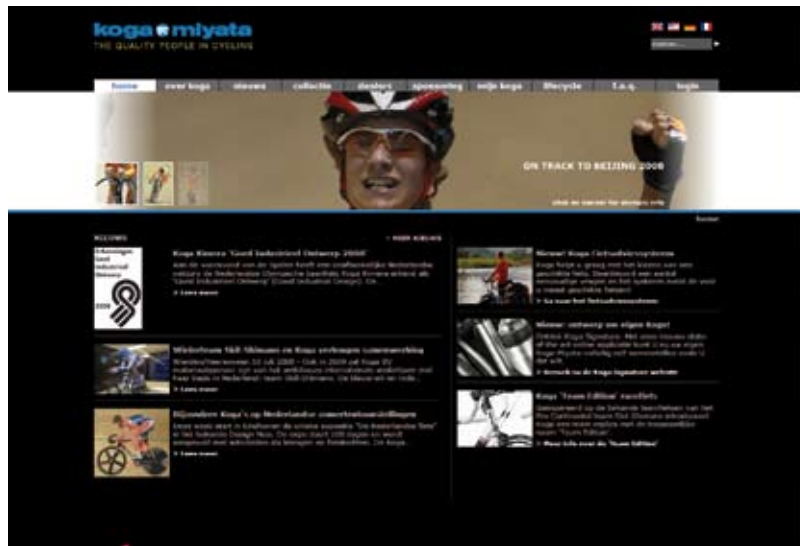

WWW.KOGA.COM



WWW.KOGA-SIGNATURE.COM

**COLOFON**

**Design/artwork/print:** Koga B.V. & Blondé Communication N.V.

**Photography:** H. Bruyns, S. Ammerlaan, C. Vos, AGU, N. Eisele Hein, Vaude/Fichtinger, P. Jeurissen/G. Johnson, Koga Customers worldwide and many more.



KOGA B.V. is part of Accell Group N.V., Accell Group is an international group of companies active in the design, development, production, marketing and sales of innovative, high-quality bicycles, bicycle parts and accessories and fitness equipment.

Selected Koga Dealer:

Koga B.V. - P.O. box 167 - 8440 AD Heerenveen - THE NETHERLANDS